

TRANS

BOS-515 series

Low Voltage Occupancy Sensor

INSTALLATION INSTRUCTIONS

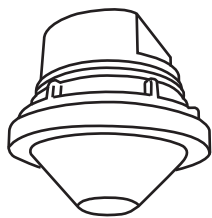

w/Lens A/B/C

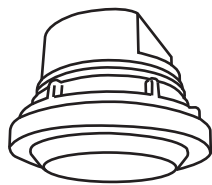

w/Lens D

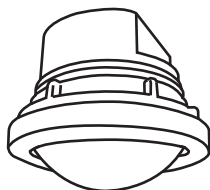

w/Lens F

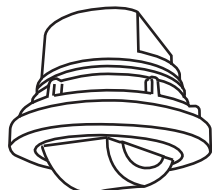

w/Lens G

*More lens options are available for this sensor.
Please refer to the Lens Datasheet for more details.

⚠ CAUTION & WARNING

- Turn power OFF at circuit breaker before installing Power Pack or Sensors.
- Do NOT touch the square window of infrared sensor under the lens assembly.
- Do Not Install To and/or Cover a Junction Box Having Class 1, 3 or Power and Lighting Circuits.
- Class 2 Device Wiring Only–Do Not Reclassify and Install as Class 1, 3 or Power and Lighting Wiring.
- Suitable wiring range 16-20 AWG solid copper wire only.

OVERVIEW

The BOS-515 series member of TRANS family is a low voltage occupancy sensor designed to signal the occupancy status for area lighting or HVAC control of energy efficient building management system.

This occupancy sensor employs a cutting edge quad element pyroelectric infrared sensor to provide omni-directional sensing capability of occupant's presence and movements. Accu-Set digital potentiometer makes the sensor setting work easier, faster and more accurate than the time wasting, inaccurate conventional analog potentiometer.

Same as all sensors in the TRANS family, the BOS-515 series is available with various mounting options and interchangeable lenses. This provides a second-to-none design and complete installation flexibility. The sensor is designed to operate in the coldest of environments, down to $-40^{\circ}\text{C}/^{\circ}\text{F}$.

The BOS-515Sxx series comes with ambient light sensor (ALS) to inhibit the lighting if ambient light levels are higher than required. The BOS-515Nxx provides all time occupancy status output with changeable ON delay to eliminate unneeded HVAC activation caused by short appearance or passer's movements.

⚠ AVERTISSEMENT & PRUDENCE

- Coupez l'alimentation au disjoncteur avant d'installer Power Pack ou capteurs.
- Ne PAS toucher la fenêtre carrée de capteur infrarouge sous l'ensemble de l'objectif.
- Ne pas installer ou couvrir une boîte de jonction ayant les classes 1 et 3 ou circuits de puissance et d'éclairage.
- Classe 2 Câblage de périphériques Seulement - Ne PAS reclasser et installer Classe 1, 3 ou alimentation et circuits d'éclairage.
- Convient gamme de câblage 16-20 AWG en cuivre massif seulement.

INSTALLATION NOTES

1. The sensor is more sensitive to the movement "crossing" the detection zones than "toward" or "away" the sensor. To obtain better sensitivity, avoid placing the sensor in line with occupant path, if possible.
2. The closer the movement is to the sensor, the more sensitive the sensor is. The higher the sensor is installed, the larger movement is required to be detected.
3. Ensure to place the sensor at least at 1.5m (5 ft.) away from air supply ducts as rapid air flow may cause false activations.
4. The sensor cannot "see" the movements behind obstacles, such as furniture, shelf, glass or partitions. As a general rule, each occupant should be able to clearly view the sensor unit.
5. For open office areas with partition which could block the sensor view to occupant movements, it is best to place the sensors over the intersection of multiple workstations. For large areas of open office or space, place multiple sensors so that there is overlap coverage with each adjacent sensor.

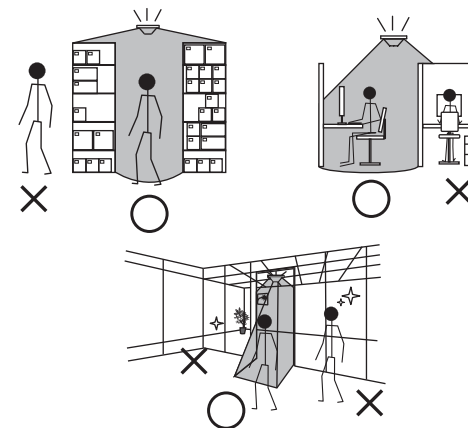

www.irtec.com

P/N: 058-51502-005

Printed in Taiwan

This product may be covered by one or more U.S. patents or patent applications.
Please visit www.irtec.com for more information.



WIRING DIAGRAM

A. Building Management System control

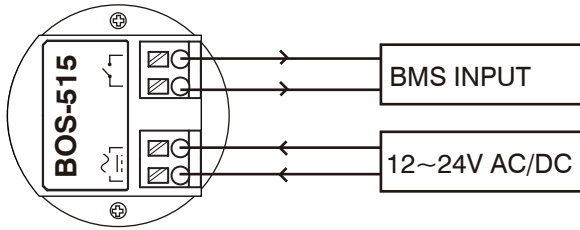

B. Power Pack control

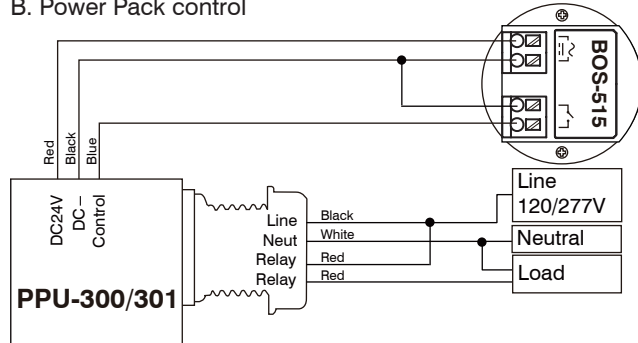

NOTE: Each IR-TEC PPU-300/301 power pack can supply power for up to 6 BOS-515 sensors. When more sensors are connected, multiple power packs may be required.

TESTING

Sensor Range Test

1. For convenience of range test, you may set the delay time to the shortest.
2. Walk within the desired range* at normal speed from various directions. The load (light, HVAC or others) connected will be switched ON as delay time set whenever sensor detects the presence or movement of occupant.
3. The LED indicator behind the lens assembly will blink to indicate sensor detection as well.

* Depending on the lens type ordered and mounting height, the sensor could have different sensing coverage as instructed on the LENS DATASHEET attached.

SENSOR SETTINGS

BOS-515Sxx

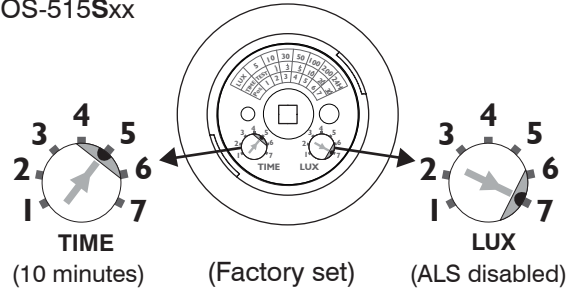

TIME – Delay Time

The BOS-515Sxx features 7 different delay times selectable via Accu-Set digital potentiometer. Select the desired delay time and point the dot mark toward the respective position, sensor output will remain active when it detects occupant's movement until the selected delay time elapsed.

LUX – Ambient Light

The BOS-515Sxx features 7 different ambient light levels selectable via Accu-Set digital potentiometer, which can be set in the same way as TIME setting. The sensor will inhibit its output if ambient light is higher than set level.

BOS-515Nxx

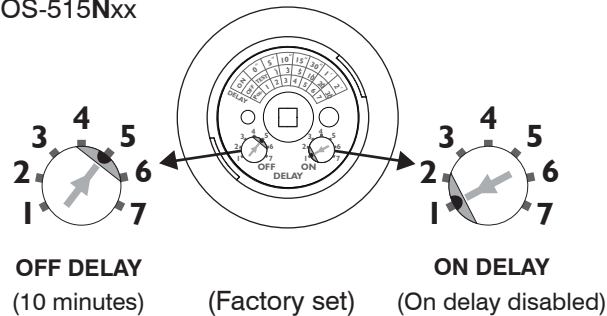

ON Delay

The BOS-515Nxx features 7 different ON delay times selectable via Accu-Set digital potentiometer. ON delay is the time that sensor will hold its output from the first detection until it detects further movement within 1 minute after the selected delay time elapsed.

OFF Delay

The BOS-515Nxx features 7 different OFF delay times selectable via Accu-Set digital potentiometer. OFF delay is the time that sensor will keep its output active after the last movement detected.

SPECIFICATIONS

Power supply	12~24 VAC/DC $\pm 10\%$
Current drain	10/24 mA @ 24 VDC, vacant/occupied
Signal output	Form A relay, NO, dry contact
Infrared sensor	Omni-directional quad element pyroelectric
Detectable speed	0.3~3m/sec. (1~10 ft./sec.)
Mounting height	Subject to the lens type applied
Detection range	Subject to the lens applied and height
ALS setting	BOS-515Sxx: 24Hr/ 5/10/30/50/100/200 lux*
ON delay setting	BOS-515Nxx: 0/5"/10"/15"/30"/1'/2'
OFF delay setting	T/1'/3'/5'/10'/20'/30', T=2 sec. for testing
Op. humidity	Max. 95% RH
Op. temperature	-40°C~55°C (-40°F~131°F)
Dimensions	Ø60 x H37mm (Ø2.36" x H1.45")

*10 lux equals to approximately 1 ft. candle

WARRANTY

IR-TEC International Ltd. warrants this product to be free of defects in materials or workmanship for a period of five years from date of shipment. There are no obligations or liabilities on the part of IR-TEC International Ltd. for consequential damages arising out or in connection with the use or performance of this product or other indirect damages with respect to loss of property, revenue, or profit, or cost of removal, installation or reinstallation.