



LP-2500/2600

Lighting Control Panels



Installation and Setup Guide

Revision 3.1
July 1999

Phone: 770-429-3043
<http://www.triateklighting.com>
sales@triateklighting.com

Introduction

Panel Overview and Illustrations

Page

Panel Layout and Design Illustration 4

Panel Installation and Connections

Panel Mounting 5

Removing/Replacing the CPU 6

Power Supply Connections 7

High Voltage Connections 8

High Voltage Compartment Divider (Optional) 9

LP-2500-CPU Switch and Zone Input Connections 10

RS-485 Serial Communication Connections 11

Adding a relay 11

Panel Layout and Design Illustration

Below is the LP-2500 Series Lighting Control Panel. The unit includes a painted steel enclosure with hinged door and lock, LP-2500-CPU microprocessor, optional LP-2500-TIB Triac Interface Board, LP-2500-RIB Contactor (Relay) Interface Module (16 contactors each), Ribbon Cables to connect LP-2500-RIBs to LP-2500-CPU, 20 amp Contactors (Relays), LP-N730012 Power Supply, LP-N470419 Primary Power Fuse Assembly and High Voltage Cover. In the following pages of this section are illustrations on the entire panel and each of the standard and optional modules.

- 1 Power Supply and fuse
- 2 High Voltage Relays
- LP-2500 = 20 amp
- LP2600 = 20 amp w/ feedback
- 3 High Voltage Section
- 4 CPU
- 5 16 Relay Interface Board
- 6 Low Voltage Section
- 7 Enclosure, with hinged door
- 8 Programmable Switch Inputs (1-24, expandable to 120)
- 9 Zone and Relay Status LEDs
- 10 High Voltage Barrier
- 11 Ribbon Cable Connection between CPU and Relay Interface
- 12 High Voltage Cover
- 13 Door Lock

LP-2600 Series

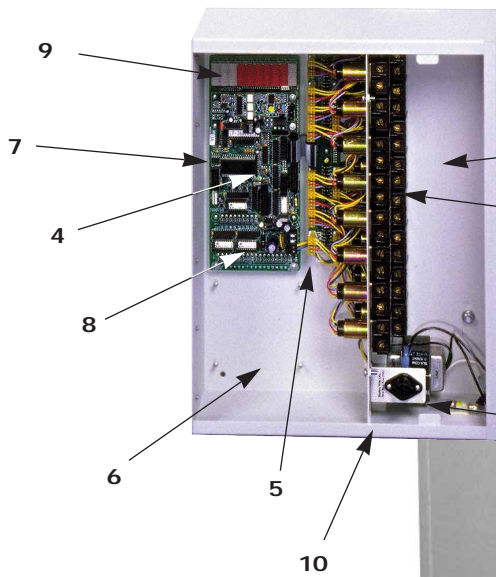

LP-2500 Series

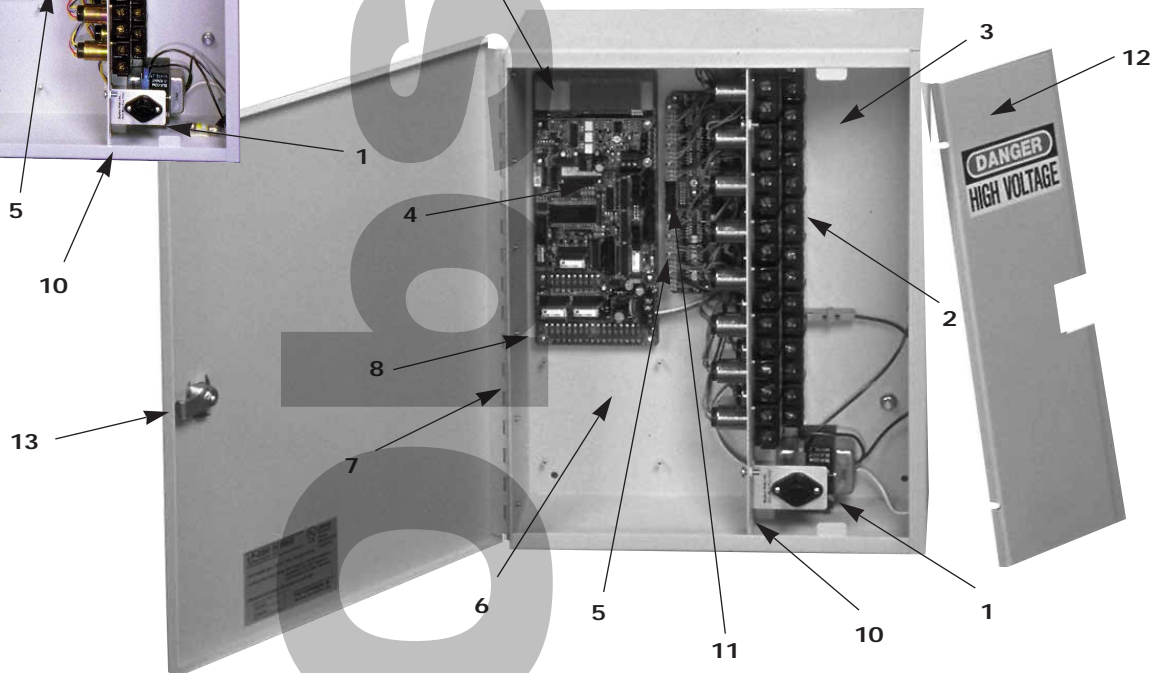

Unpack the unit and check for any type of visible damage that may have occurred during shipment.

The figure below illustrates the location of the unit's mounting holes. The top two mounting holes are keyhole shaped so you can slide the unit over mounting screws, avoiding the need to hold the unit while trying to secure the mounting screws. Use wall anchors capable of supporting more than 85 pounds (60 relay unit).

Remove the LP-2500/2600-CPU and any other electronic modules in the unit prior to drilling any holes in the enclosure. Metal shavings

from drilling could lodge on the electronic modules and cause damage. Once drilling is complete, remove all shavings and replace all electronic modules as installed from the factory. All wiring should be in accordance with local regulations and the National Electric Code. Control signal wiring to the low voltage side of the unit should not be run in the same conduit as line voltage wiring or other conductors that supply highly inductive loads such as generators, motors, or high voltage circuits located on the high voltage side of the unit.

Panel Dimensions

Panel Capacity	A	B
16	17 1/2"	15 3/8"
32	30 1/2"	28 5/8"
48	43 1/2"	41 1/2"
60	53 1/2"	51 1/2"

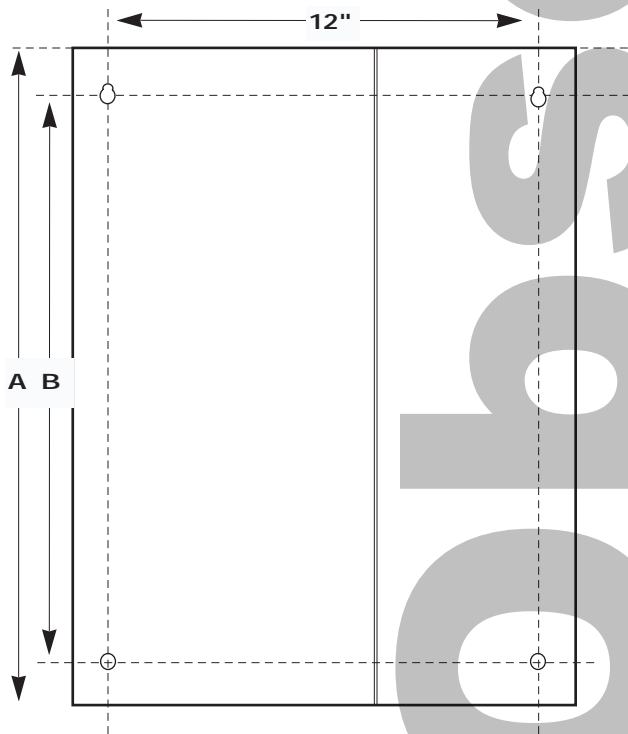

Removing/Replacing CPU

- 1.) Remove power from LP-2500/2600 CPU. Connection is of the removable type, for easy removal from the CPU.
- 2) Remove ribbon cable for 'Relay 1-32.' Be sure to mark cable so that when reinstalling, cable is reinserted into correct header.
- 3) Remove ribbon cable for 'Relay 33-60.' Be sure to mark cable so that when reinstalling, cable is reinserted into correct header.
- 4) Remove all phillips head screws that attach CPU to the LP enclosure.

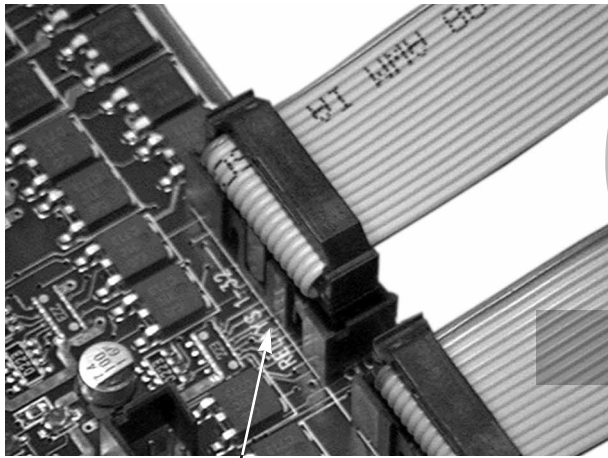

Relay Connectors

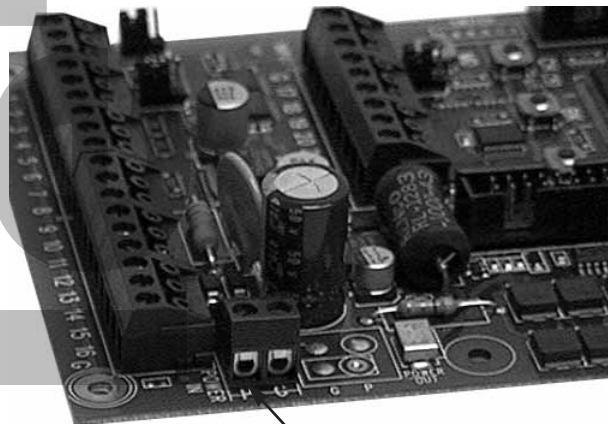

Removable Power Connector

- 1.) To replace the CPU follow steps 1-4 above in reverse order

Power Supply Connections

The unit can be powered by either 120 or 277 VAC. A fuse and dual primary transformer are utilized to offer maximum flexibility during installation. This factory mounted transformer powers the LP-2500-CPU, LEDs and associated low voltage coils on the contactors (relays).

The unit is factory wired for 120VAC, however the unit can be powered by 277 VAC by disconnecting the 120VAC primary connection (quick connect) from the output of the fuse and connecting the 277V lead (quick connect) as shown below.

Once the correct supply voltage is applied to the unit, the "STATUS" LED #1 on the -2500-CPU will blink. Also, a second LED located a couple of inches below the LED barcharts will illuminate.

WARNING: Keep the unused lead (120V or 227V) insulated from other leads and case ground.

Status LED's

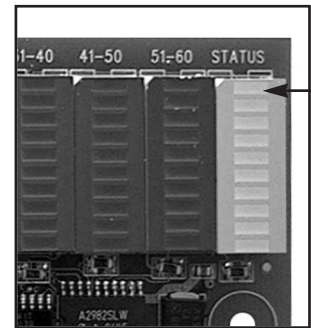

Status LED #1 - Flashes when Power is applied

120 V Power Supply Wiring

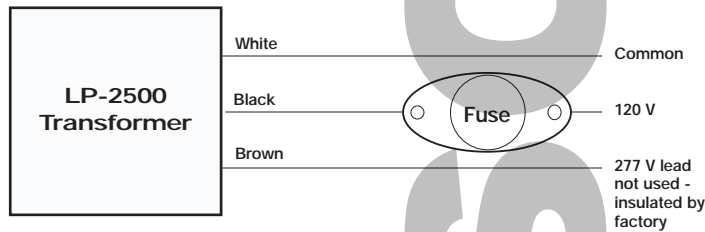

277 V Power Supply Wiring

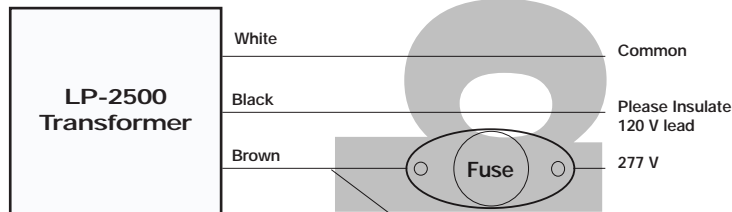

277 V lead will need to be connected to output of fuse by installer

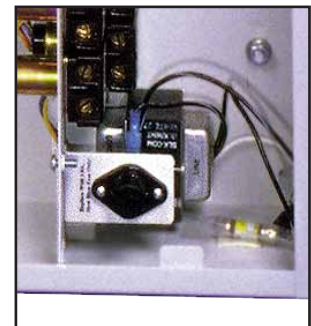

LP-2500/2600 Transformer and Fuse

High Voltage Connections

The unit is equipped with contactors capable of switching up to 20 amperes at 277 VAC (Canadian versions 347 VAC). Each contactor can be easily assigned to any of the unit's zones. This is covered in the "Programming" section of this manual. Below

are typical wiring diagrams. Be sure not to exceed 20 amperes per contactor. If the high voltage wiring requires both 120V and 277V, TRIATEK's LP-2500-DVD High Voltage Divider will be required.

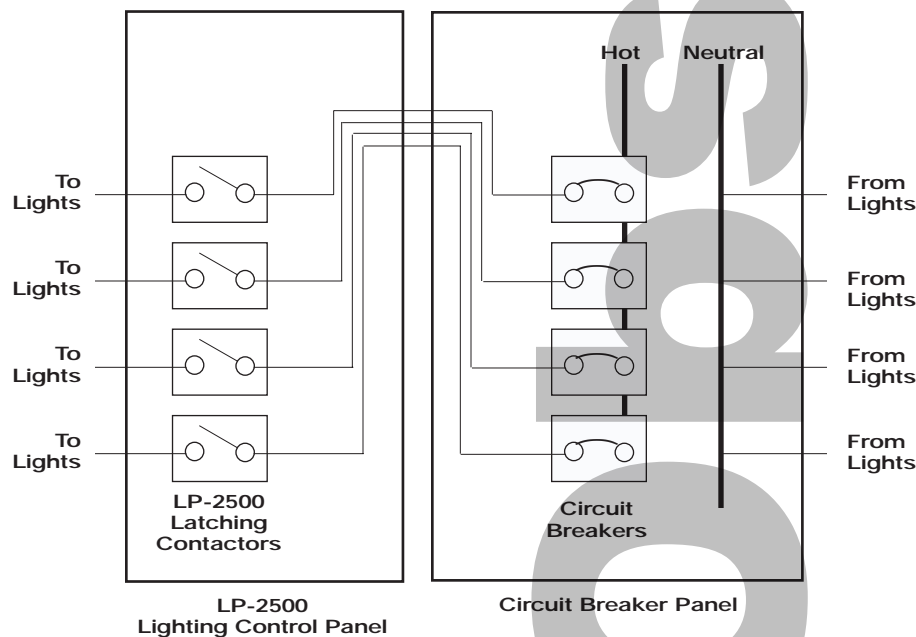
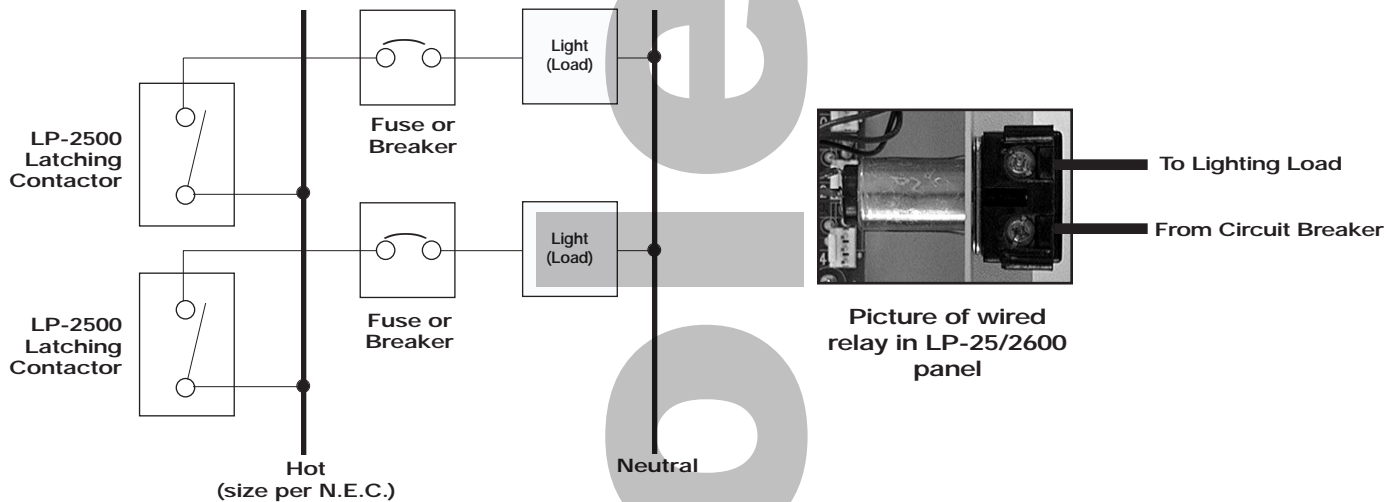

High Voltage Compartment Divider (Option)

Below is an illustration of the optional LP-2500/2600 DVD High Voltage Compartment Divider. It provides the capability to separate two different feeder voltages within the unit's high voltage compartment. Many installations may require both 120V and 277V lighting circuits in the same LP-2500/2600 Lighting Interface Panel. This module mounts horizontally between any of the contactors to separate these different voltages.

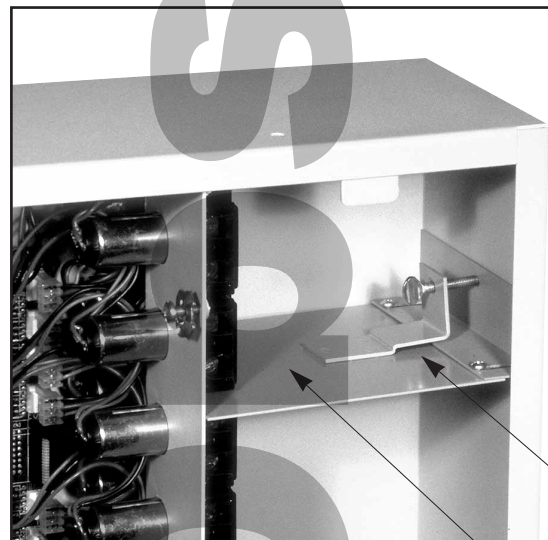
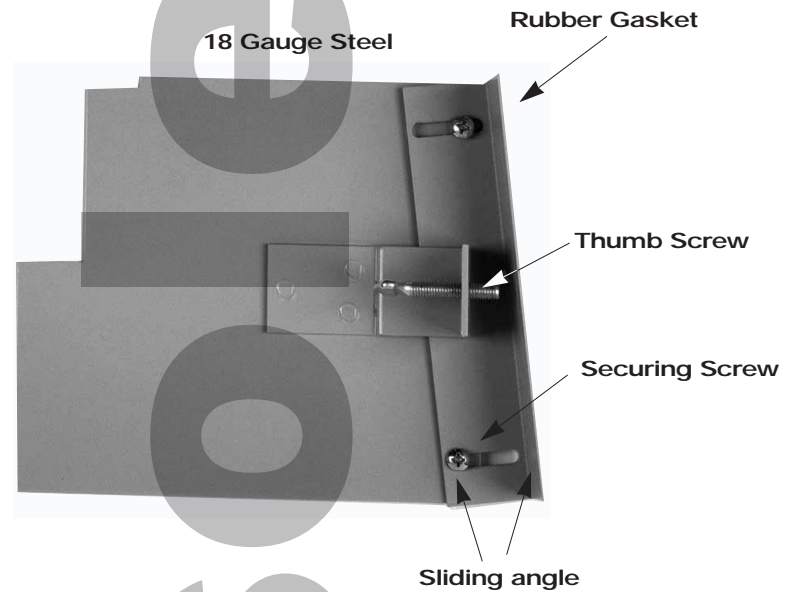

Slide In

LP-2500-CPU Input Connections

The LP-2500 or LP-2600 CPU provides for up to 24 switch input connections. The unit is capable of up to 120 programmable switch inputs with the addition of three 32-input interface boards.

The programmable switch inputs can accept maintained contacts or momentary contacts up to 24 VDC. This requires sinking capability to pull the input below 1 VDC. Typically, dry contacts (0 V) are used to eliminate the need for an external power supply to power the contacts on the controller. One end of the switch or contact will need to be connected to terminal "G" and the other to terminal "1-24". All terminals labeled "G" are common. **Do not apply AC voltage to any of these terminals.**

Momentary switches which have both an ON and OFF contact will require two switch inputs on the CPU. Sample wiring diagrams are shown for various input types. If you are switching 24 VAC then TRIATEK's optional LP-2500-TIB Triac Interface Board (32 inputs each) will be required. All switch inputs must be defined in the CPU software via the LP-PK2 programmer kit.

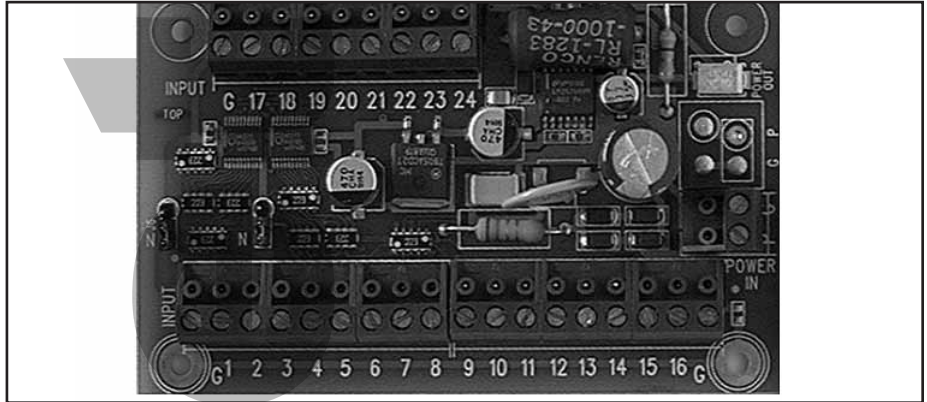

24 Switch Input Connectors on LP-2500 or LP-2600 CPU

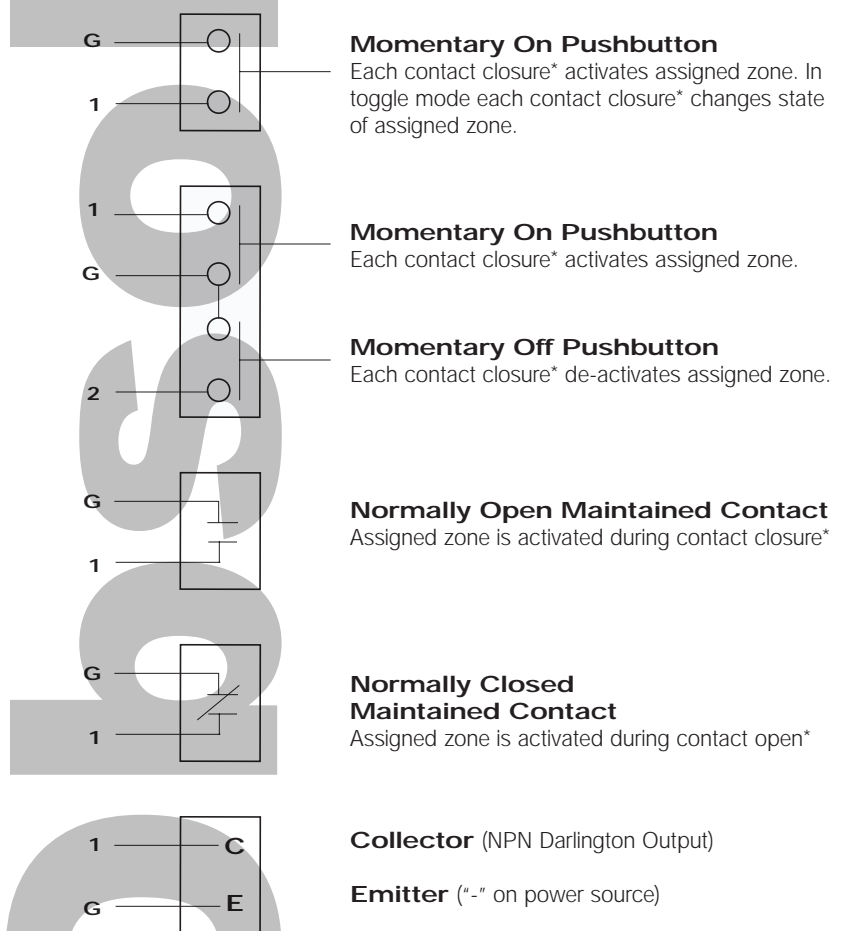

*Switch defined as normally open polarity in software

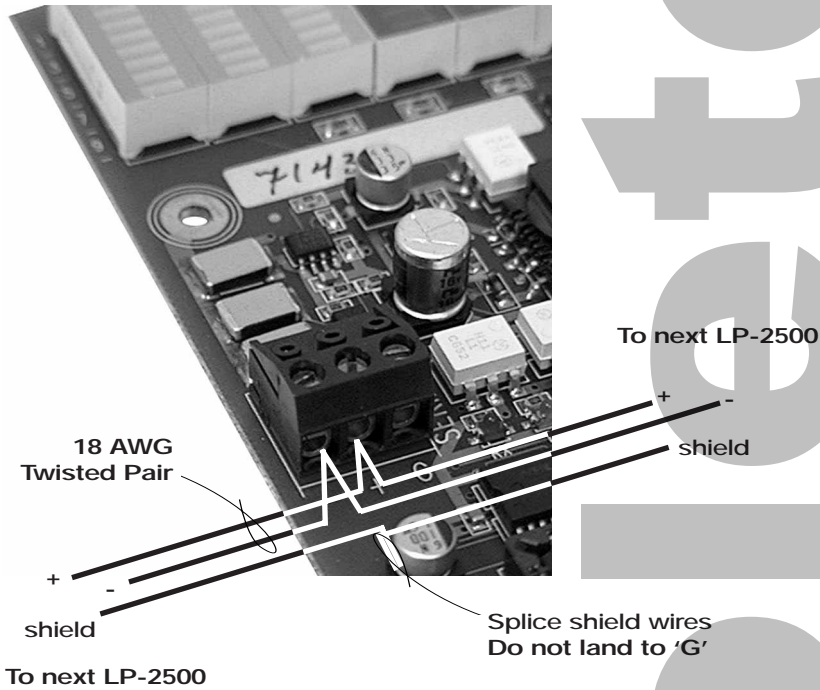

To connect communication wire:

- 1) Disconnect power to the LP-2500/2600 CPU.
- 2) Connect incoming and outgoing transmit "+" to "T+" on the RS-485 connector.
- 3) Connect incoming and outgoing transmit "-" to "T-" on the RS-485 connector.
- 4) When a shield wire is used, splice incoming and outgoing shield wires together. **Do not land shield wire to 'G.'**
- 5) Reconnect power to the LP-2500/2600 CPU.
- 6) 'G' is not used.

You should now be able to communicate to the LP-2500/2600 over the twisted pair network. See TRIATEK's "LP-2500/2600 RS-485 Protocol Guide" for communication protocol information.

Adding A Relay

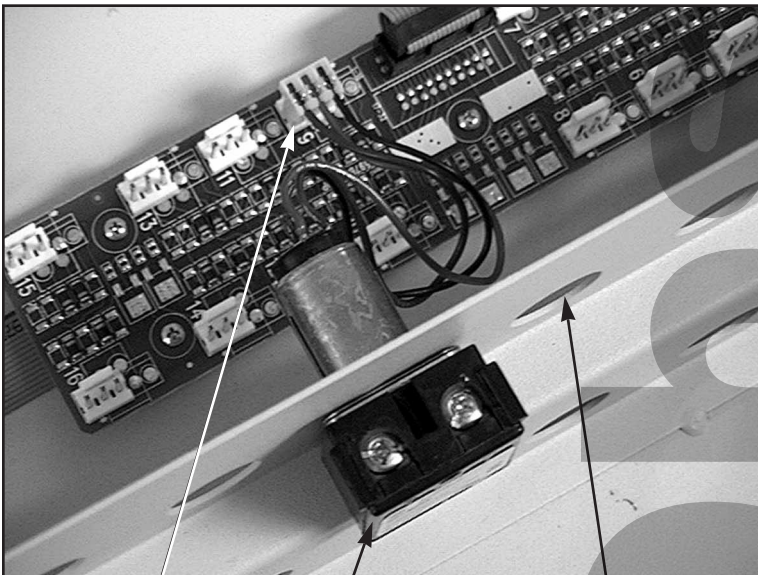

To add a relay, insert the relay through an available mounting hole from the high voltage department. Plug the 3 pin (LP-2500) or 5 pin (LP-2600) connector from the relay to the correct header on the Relay Interface Board.

Be sure to assign the new relay to a zone using the LP-PK Programmers Kit (see LP-PK Software Setup Guide for detailed instructions).

See 'High Voltage Connections' in this manual for details on high voltage wiring of the relay.

obsoletete

Phone : 770-429-3043
<http://www.triateklighting.com>
sales@triateklighting.com