

## Hardware Installation and Setup Instructions

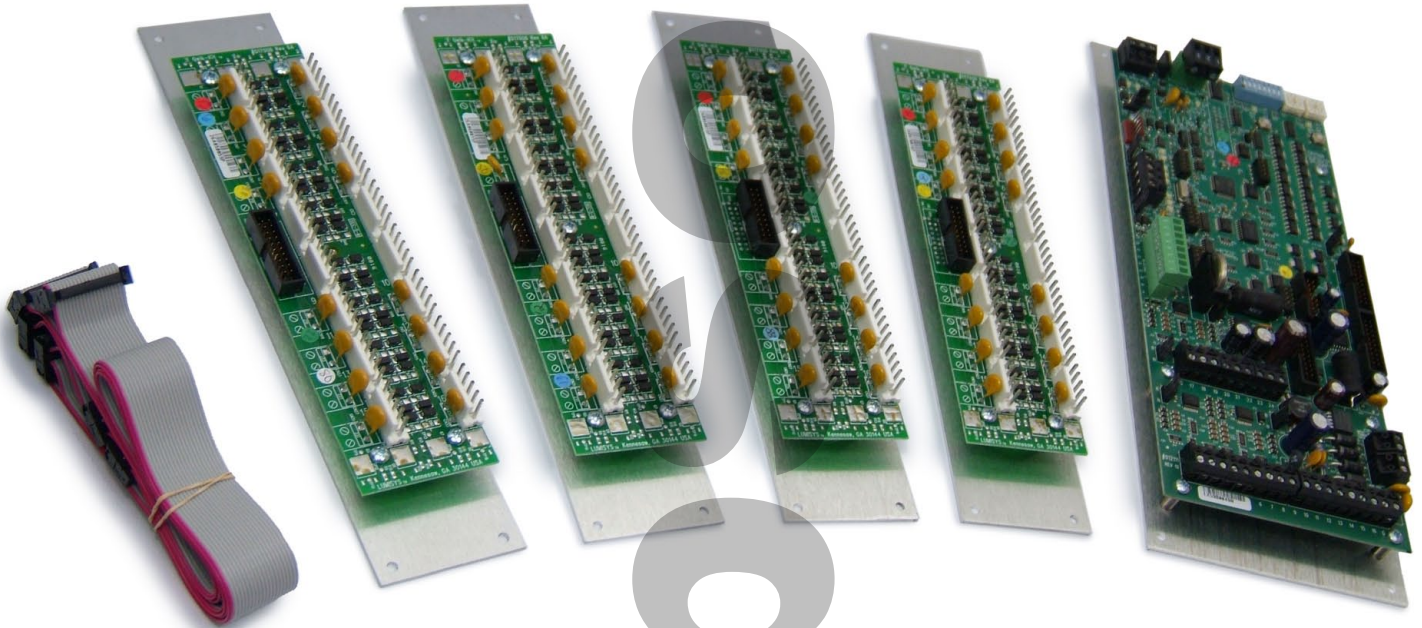

## Table of Contents







Overview	
Document	3
Component	3
Assembly	3
Dimensions	4
Preparation	4
Mounting	4
Connection	5
Controller Setup	8
Optional Equipment	9
RK Configuration Worksheet	10

Visit [www.BRTint.com/tandc.html](http://www.BRTint.com/tandc.html) for Terms and Conditions of Sale

## Attention

This section serves as a notice of the immediate or potential dangers involved when working with the equipment described throughout this manual. Any person involved in installation, maintenance, or service of the equipment should first carefully examine the equipment and read the instructions contained in this manual to ensure that personal and/or equipment injury is avoided.

The following safety messages appear throughout this manual to alert of immediate or potential danger to life as well as property.

	<b>NOTE</b> : Indicates an important note.
	<b>TIP</b> : Indicates a helpful tip or trick.
	<b>SAFETY REMINDER</b> : Applicable safety instructions will be included with this symbol.
	<b>DANGER</b> : Indicates an immediately hazardous situation which, if not avoided, will result in serious injury or death.
	<b>WARNING</b> : Indicates a potentially hazardous situation which, if not avoided, may result in serious injury or death.
	<b>CAUTION</b> : Indicates a potentially hazardous situation which, if not avoided, may result in minor or moderate injury.

## Disclaimer

This equipment has been tested and found to comply with the limits for a Class A digital device, pursuant to part 15 of the FCC Rules. These limits are designated to provide reasonable protection against harmful interference when the equipment is operated in a commercial environment. This equipment generates, uses, and can radiate radio frequency energy and, if not installed and used in accordance with the instruction manual, may cause harmful interference to radio communications. Operation of this equipment in a residential area is likely to cause harmful interference, in which case the user will be required to correct the interference at his own expense.

Instructions contained in this user's guide should be performed only by qualified persons in accordance with local and national codes. Blue Ridge Technologies International, LLC and its affiliates assume no responsibility for any consequences related to the improper use of this manual.

### Overview : Document

This document provides mounting and connection instructions for the following Blue Ridge Technologies Retrofit Kit (RK) products:

Retrofit Kit 3 (RK3)

RK3 is compatible with:

- General Electric Panels (RR7)
- Horton Controls Panels (RR7)
- WattStopper Panels (RR7)
- Lithonia Lighting Panels (RR7)
- Triatek L2500 Panels (RR7)
- ILC Panels (2R7)

Sections of this Install Guide apply to optional equipment and may not be applicable. See the Optional Equipment section for details.

Siemens' P1 and Automated Logic Corporation's BACnet ARCnet protocols are only available to authorized integrators.

For RK integration with a Building Automation System (BAS) as well as software configuration refer to the Application Guide.

### Overview : Component

The RK3 includes the following items :

- 1 - Controller
- 2 - Relay Interface Boards (RIB-A) with (16) Relay Outputs
- 2 - Relay Interface Boards (RIB-B) with (16) Relay Outputs
- 2 - 20-Pin Ribbon Cables
- 1 - BT485 BAS Network Terminator (BT485 Terminator)

The optional PT3 3-Wire Relay Interface Pigtail includes the following items :

- 1 - Pigtail
- 3 - Insulation Displacement Connectors (IDC)

### Overview : Assembly

1. Mounting Fastener Point
2. Mounting Plate
3. Controller
4. RIB

RIB Identification

5. RIB-A (Outside Ribbon Cable Socket)
6. RIB-B (Inside Ribbon Cable Socket)

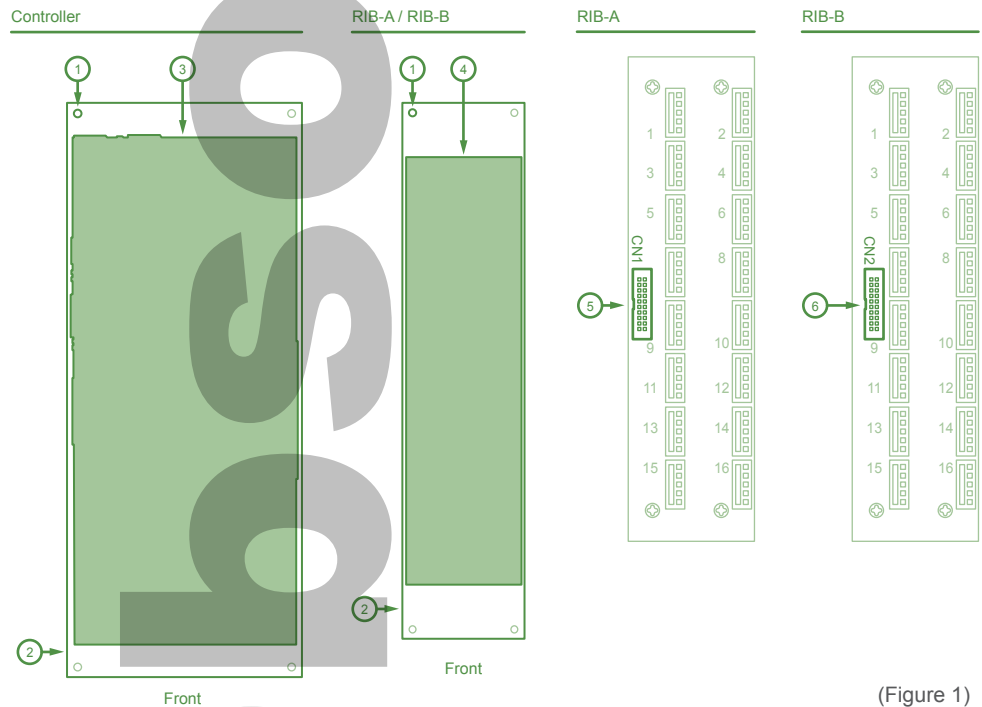

(Figure 1)



Disconnect line voltage power before performing RK installation.



All circuits must be tested for wiring errors and shorts prior to RK installation.

Before handling any RK components, the technician should be grounded to prevent circuit board damage.

DO NOT apply control power to the RK Relay Outputs. Remove any power source from the control side of the relays prior to RK installation.

## Overview : Dimensions

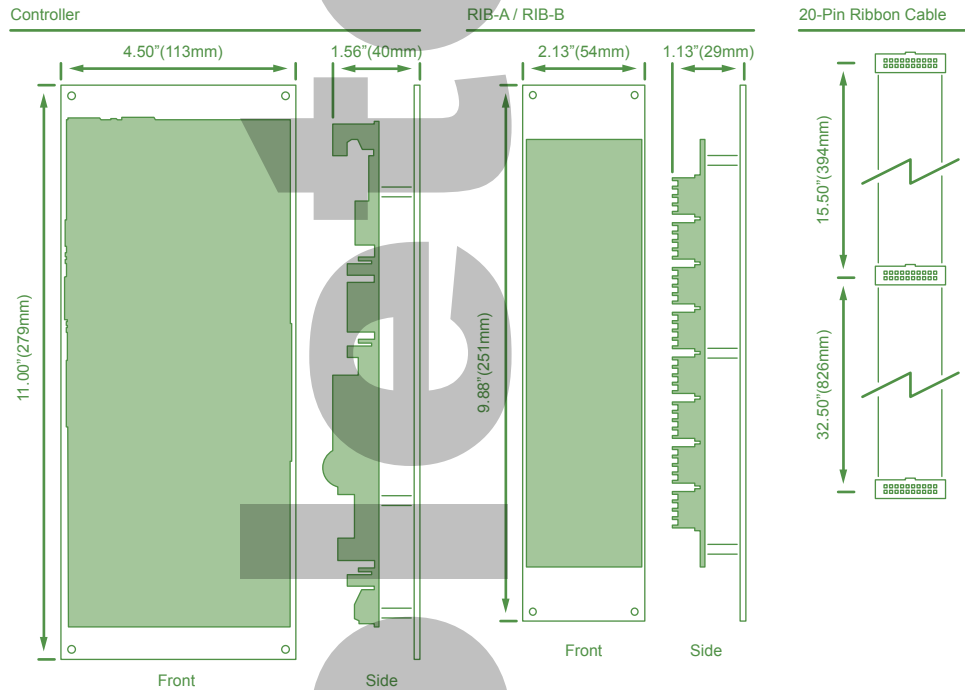

(Figure 2)

## Preparation

Remove the existing control system.

1. Disconnect power from the panel.
2. Label all low voltage leads.
3. Unfasten or cut existing low voltage leads. Do not cut existing leads too short.
4. Unfasten and remove existing controller electronics. Remove any power source from the control side of the relays.
5. Remove any dust or debris from low voltage bay of the panel.

## Mounting

### Grouping Strategy

Retrofit Kits permit soft-wiring Inputs to Relay Outputs. This allows relays to be connected to any Relay Output terminal on the RIB while maintaining the original system configuration. Soft-wiring is achieved by a software based Grouping method. The Input (switches, occupancy sensors, etc) is assigned control of a Group. Each Group contains Relay Outputs (relays and related lighting circuits). Therefore, an Input commands its assigned Group and all the Relay Outputs contained within that Group. These Group assignments may be configured to suit any application ensuring maximum flexibility during physical installation. Connections may be recorded utilizing the RK Configuration Worksheet. (See page 10)

Example:

Original Configuration

- Input 1 controls Relay 1

Retrofit Configuration

- Due to panel arrangement Relay 1 is in close proximity to Relay Output 17 on RIB-B
- Therefore Relay 1 is connected to Relay Output 17.
- During software configuration Input 1 is assigned control of Group 1 and Relay Output 17 is placed in Group 1.
- The original configuration is maintained. Input 1 controls Relay 1 through Group 1.

Determine position of all components prior to installation. Consider these factors during this process.

- Ensure the all RIB's are near the relays with which they will interface.
- RIB position should minimize cross-board wiring (relay control leads lying across boards).
- Ensure Controller is near the power, input, and network leads.
- Confirm the distance between the Controller, RIB's, and Optional Equipment does not exceed the length of the ribbon cables.
- Allow a minimum of 0.75" (20mm) clearance between component mounting plates for ease of wiring.

The Retrofit Kit may now be mounted in the low voltage bay.

1. Confirm power is disconnected from the panel.
2. Fasten the Controller in position utilizing self-tapping screws. Drive a screw through each Mounting Fastener Point. Keep the board clear of any metal shavings. (Figure 1)
3. Repeat fastening procedure for each component required in the application.
4. Remove any metal shavings from the panel.

## Connection

All low voltage leads are terminated on the Controller and RIB's. (Figure 3)

1. Confirm power is disconnected from the panel.
2. Complete ribbon cable terminations to connect Controller, RIB's, and Optional Equipment. Disconnect power to the Controller before installing or removing ribbon cables. Failure to do so could result in damage to the electronics.
  - a. Route cables in a neat fashion to prevent interference during remaining installation.
  - b. Connect one RIB-A and one RIB-B per ribbon cable. Do not combine like RIB styles on a ribbon cable. The sequence of RIB-A and RIB-B per ribbon cable is not specific.
3. Connect the relay control leads to the RIB's Relay Outputs utilizing Pigtails and IDC. DO NOT apply control power to the RK Relay Outputs. Remove any power source from the control side of the relays.
  - a. Route leads.
  - b. Connect Pigtails and relay control leads with IDC's. Refer to color coordination to confirm correct connection.
  - c. Install Pigtail's RIB Connector on appropriate RIB pins. Confirm the connection's orientation. (Figure 4)
  - d. Repeat procedure for each relay.
4. Connect existing power, input, and network leads to the Controller. Controller screw terminals accept a 0.4 x 2.5mm slot head screw driver.
  - a. Route leads.
  - b. Cut to length and strip as appropriate.
  - c. Insert stripped lead into screw terminal and tighten screw.
  - d. Repeat for each lead.

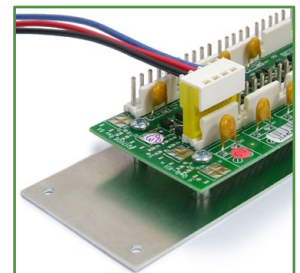
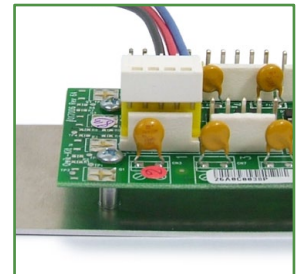
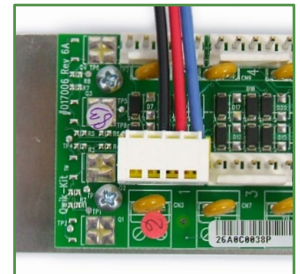
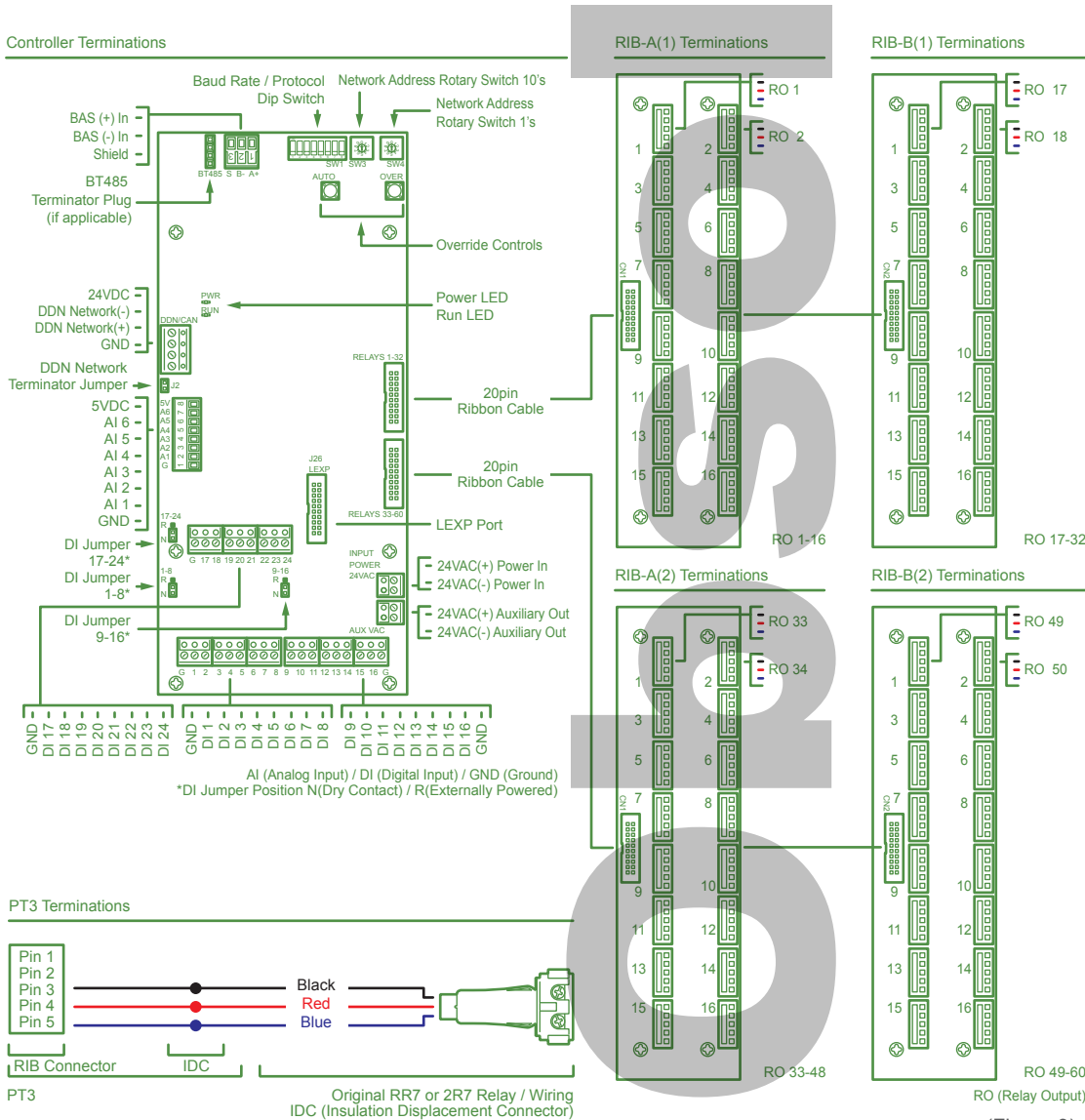

(Figure 4)

(Figure 3)

## Connection

### Power Specifications

Power In: 24VAC +/-10%, 30VA, 50-60 Hz  
Auxiliary Out: 24VAC Full Wave Rectified

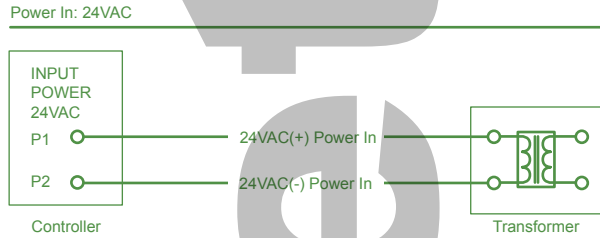

(Figure 5)

### Digital Input Specifications

Digital Input: 24 two-wire inputs

Software Configuration: Maintained, state change, momentary on/off, momentary on, or momentary off

Jumper Configuration: 8 input segments, dry contact (N) or 24VDC externally powered (R)

Wire Requirement / Maximum Length: 18AWG (Solid or Stranded) / Dry Contact 500'(152m) or externally powered 1,000'(304m)

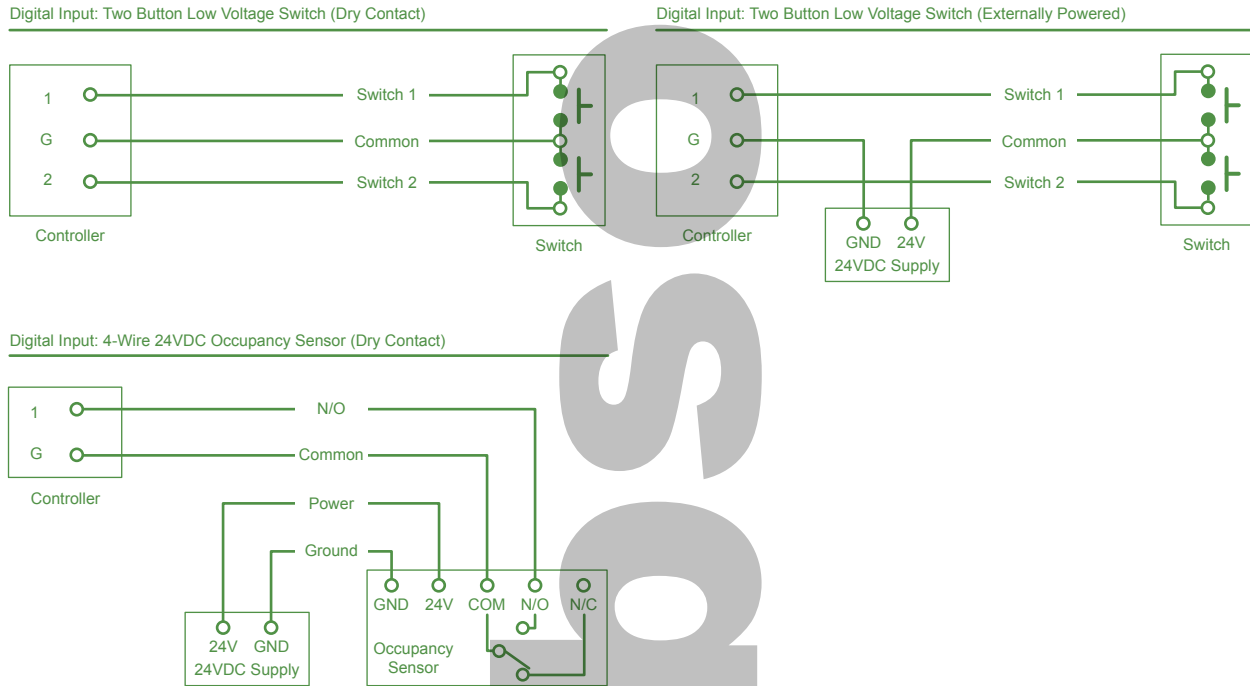

(Figure 6)

### Analog Input Specifications

Analog Input: 6 three-wire 0-5VDC inputs

Wire Requirement / Maximum Length: 18AWG (Solid or Stranded) / 250'(76m)

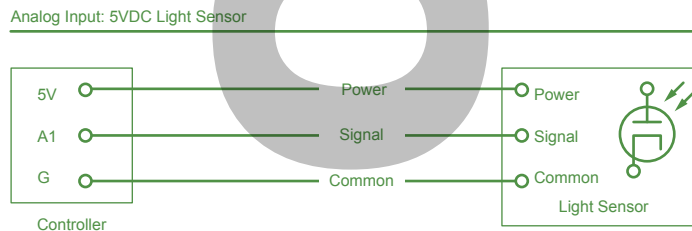

(Figure 7)

### Terminations : Low Voltage

#### BAS Network Specifications

Topology: RS-485, 3 conductor (+, -, and shield), daisy chain wiring (no stars or t-taps)

Wire Requirement / Maximum Length: Belden 8760 / 4000'(1216m)

#### BACnet MS/TP

Baud Rate: DIP switch selectable 9.6K, 19.2K, 38.4K, or 76.8K

Device Profile: BACnet Advance Application Controller (AAC)

Address Range: 1 – 99 selectable with rotary dials

Unit Load: Full unit load, 32 devices per MS/TP segment

Points: See Application Guide and PIC Statement

#### N2

Baud Rate: DIP switch selectable 9.6K

Address Range: 1 – 255 selectable with rotary dials and DIP switch

#### P1

Baud Rate: DIP switch selectable 4.8K, 9.6K, 19.2K, or 38.4K

Address Range: 1 – 99 selectable with rotary dials

See Automated Logic Corporation's *ARC156 Wiring Technical Instructions* for the latest BACnet ARCnet specifications.

Install BT485 Terminator if RP is operated as end of line device (first or last device on network). BT485 Terminator requires no specific orientation in relation to the terminal.

See Controller Setup for Address and Protocol settings.

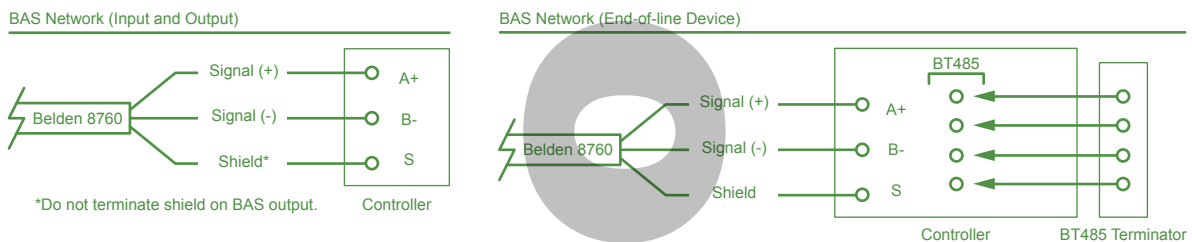

(Figure 8)

### DDN Network Specifications

Protocol: Digital Device Network (DDN)

Address Range: 1-60, DIP switch selectable

Topology: Daisy Chain Wiring (no stars or t-taps)

Wire Requirement: CL3P, 22AWG, 4 conductor, Unshielded

Maximum Stations (w/o external power): 10 CTS-DDN

Maximum Length (w/o external power): 500'(152m)

Maximum Stations (w/ external power): 60 one-button, 30 two-button, or a combination for 60 buttons total

Maximum Length (w/ external power): 2,000'(610m)

Power / Draw: 24VDC / 15mA per CTS-DDN

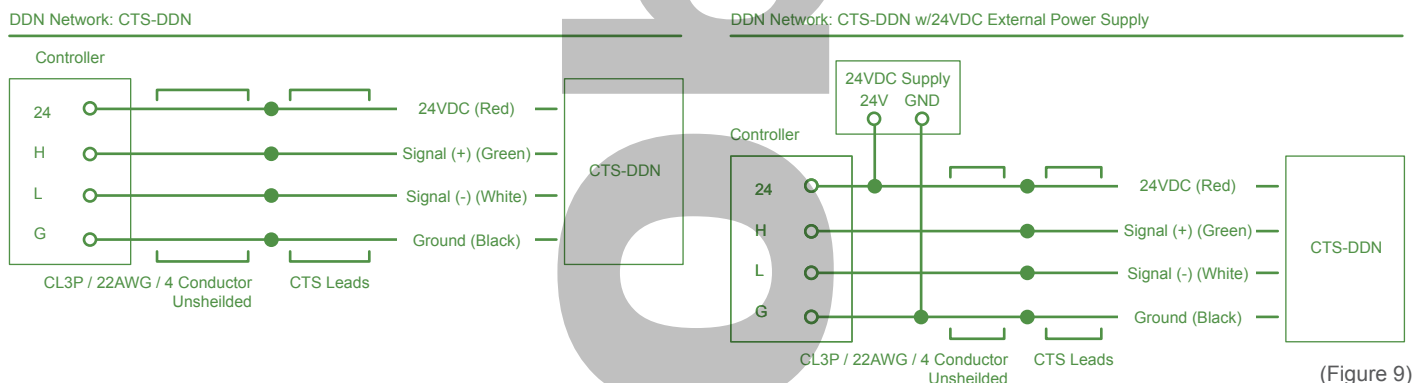

(Figure 9)

### Controller Setup

Controller configuration and RK testing are the final steps of installation. (Figure 11)

#### Setup

1. Confirm power is disconnected from the Controller and the Power / Run LED's are not illuminated.
2. Set the DDN Network Terminator Jumper if utilizing DDN Network. Two devices on the DDN Network should be set for network termination. If the Controller is the end-of-line, terminate the Controller and the device at the opposite end of the network. If the Controller is positioned at a mid-point on the network, terminate devices at the opposite ends of the network either side of the Controller.
3. Set the Digital Input (DI) Jumpers.
4. Set the Baud Rate / Protocol Dip Switch for protocol and baud rate.
5. Set the Network Address.

#### Testing

1. Connect power to the Controller. Wait 10 seconds for power up.
2. Confirm normal LED operation.  
Power LED: Solid illumination  
Run LED: Continuous blinking
3. Press and release the Over Button. Confirm the Relays change state On/Off.
4. Press and release the Over Button again. Confirm the Relays change state On/Off.
5. Press and release the Auto Button to exit override mode.
6. Test procedure complete.

#### Controller Terminations

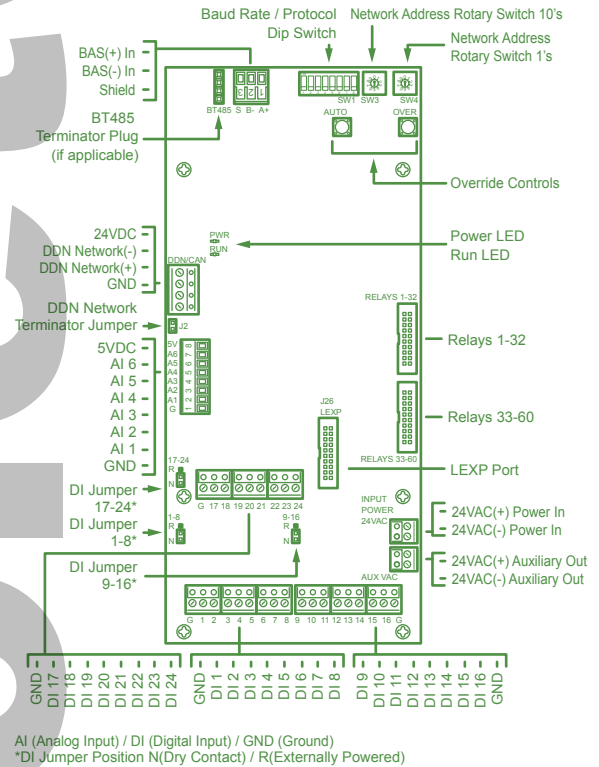

#### Network Address

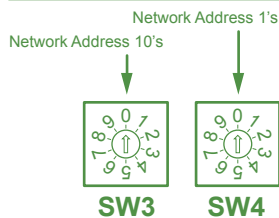

See right for N2 addresses 100-255

#### Digital Input (DI) Jumper

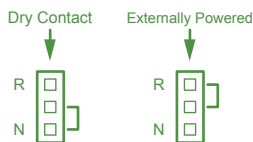

#### DDN Network Terminator Jumper

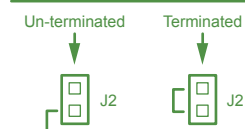

#### Baud Rate / Protocol Dip Switch: BACnet MS/TP

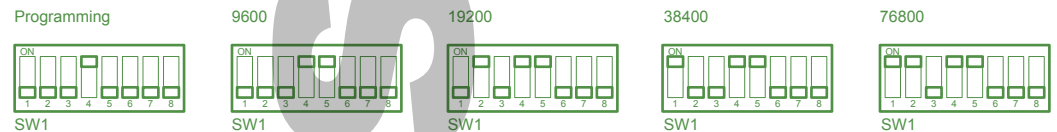

#### Baud Rate / Protocol Dip Switch: N2

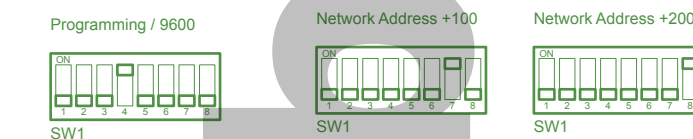

#### Baud Rate / Protocol Dip Switch: P1

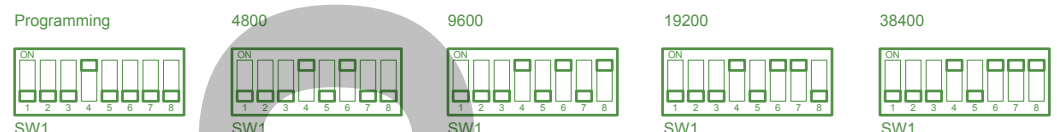

#### Baud Rate / Protocol Dip Switch: BACnet ARCnet

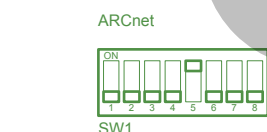

(Figure 10)



### Optional Equipment

#### LEXP Specifications (Figure 11)

Description: Digital Input Expansion Card  
 Digital Input: 32 two-wire inputs  
 Software Configuration: Maintained, state change, momentary on/off, momentary on, or momentary off  
 Jumper Configuration: 8 input segments, dry contact (N) or 24VDC externally powered (R)  
 Wire Requirement / Maximum Length: 18AWG (Solid or Stranded) / Dry Contact 500'(152m) or externally powered 1,000'(304m)  
 Dimensions: 6.00"(152mm)H x 4.50"(113mm)W x 1.13"(29mm)D

#### ETA Consolidated Mounting Plate Specifications:

Description: Mounts several components on single 14ga aluminum plate  
 Dimensions: 10.00"(254mm)H x 8.44"(214mm)W  
 E Option: 1 ETA for mounting Controller / 2 RIB's. Remaining RIB's on individual plates. 1.88"(48mm)D  
 C Option: 1 ETA for mounting Controller / 2 RIB's / LEXP (LEXP mounted atop Controller with hinged stand-offs). Remaining RIB's on individual plates. 3.13"(79mm)D  
 C2 Option: 2 ETA, 1st ETA for mounting Controller / 2 RIB's / LEXP (LEXP mounted atop Controller on hinged stand-offs). 2nd ETA for mounting 2 RIB's / LEXP (LEXP mounted between RIB's). 3.13"(79mm)D

#### PT3 3-Wire Relay Interface Pigtail Specifications:

Description: 18"(457mm)L, 18AWG, 3-wire  
 Pin/Color Code: 1/Unused, 2/Unused, 3/Black, 4/Red, 5/Blue  
 RIB Connection: Keyed 5pin plug-on connector  
 Relay Connection: 3 Insulation Displacement Connectors (IDC), 22-16AWG, UL Listed

LEXP Terminations

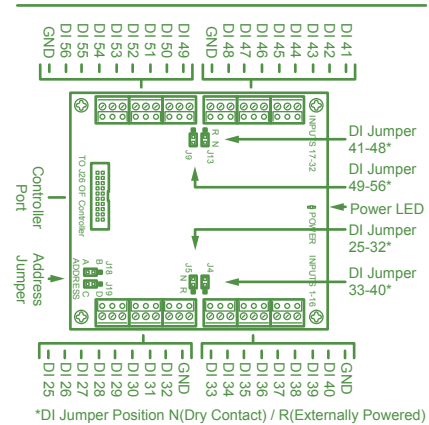

(Figure 11)



## RK Configuration Worksheet RIB-A (1)

RIB Terminal Number (Relay Output)	Original Relay Number	Area Controlled	Original Input Number
1(1)			
2(2)			
3(3)			
4(4)			
5(5)			
6(6)			
7(7)			
8(8)			
9(9)			
10(10)			
11(11)			
12(12)			
13(13)			
14(14)			
15(15)			
16(16)			

## RIB-B (1)

RIB Terminal Number (Relay Output)	Original Relay Number	Area Controlled	Original Input Number
1(17)			
2(18)			
3(19)			
4(20)			
5(21)			
6(22)			
7(23)			
8(24)			
9(25)			
10(26)			
11(27)			
12(28)			
13(29)			
14(30)			
15(31)			
16(32)			



## RK Configuration Worksheet RIB-A (2)

RIB Terminal Number (Relay Output)	Original Relay Number	Area Controlled	Original Input Number
1(33)			
2(34)			
3(35)			
4(36)			
5(37)			
6(38)			
7(39)			
8(40)			
9(41)			
10(42)			
11(43)			
12(44)			
13(45)			
14(46)			
15(47)			
16(48)			

## RIB-B (2)

RIB Terminal Number (Relay Output)	Original Relay Number	Area Controlled	Original Input Number
1(49)			
2(50)			
3(51)			
4(52)			
5(53)			
6(54)			
7(55)			
8(56)			
9(57)			
10(58)			
11(59)			
12(60)			