

Hardware Installation and Setup Instructions

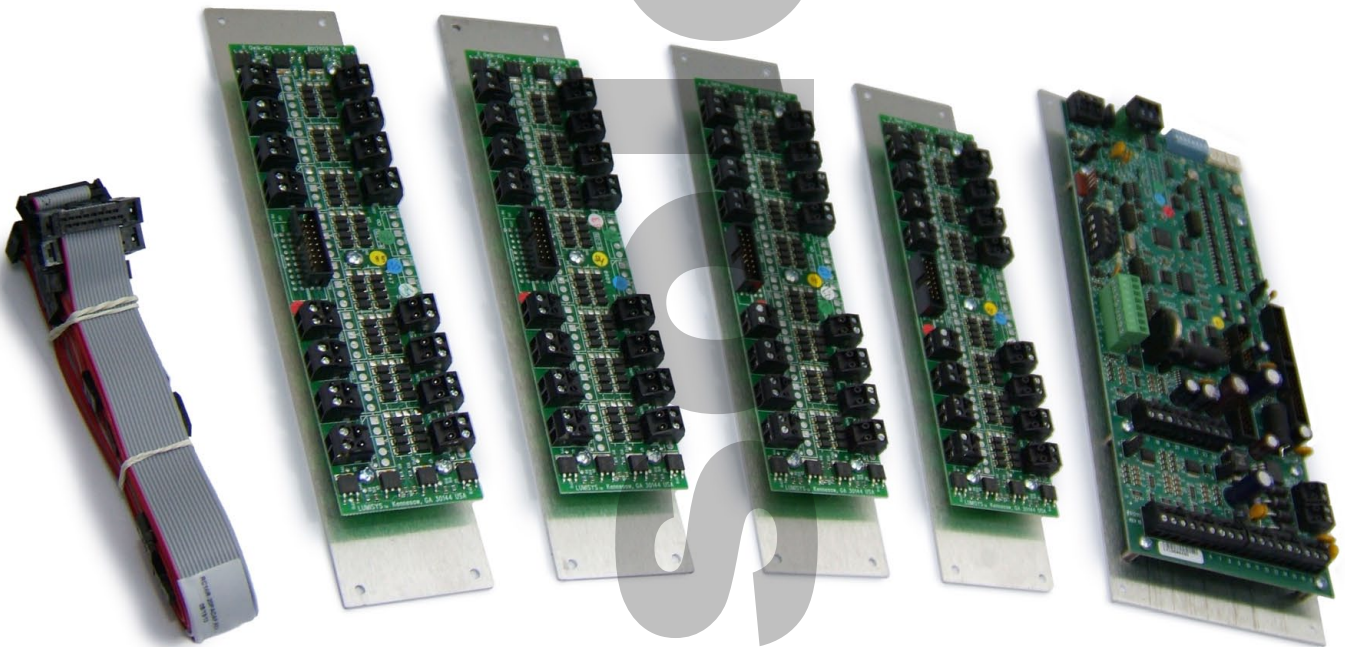

Table of Contents







Overview	
Document	3
Component	3
Assembly	3
Dimensions	4
Preparation	4
Mounting	4
Connection	5
Controller Setup	8
Optional Equipment	9
RK Configuration Worksheet	10

Visit www.BRTint.com/tandc.html for Terms and Conditions of Sale

Attention

This section serves as a notice of the immediate or potential dangers involved when working with the equipment described throughout this manual. Any person involved in installation, maintenance, or service of the equipment should first carefully examine the equipment and read the instructions contained in this manual to ensure that personal and/or equipment injury is avoided.

The following safety messages appear throughout this manual to alert of immediate or potential danger to life as well as property.

	NOTE : Indicates an important note.
	TIP : Indicates a helpful tip or trick.
	SAFETY REMINDER : Applicable safety instructions will be included with this symbol.
	DANGER : Indicates an immediately hazardous situation which, if not avoided, will result in serious injury or death.
	WARNING : Indicates a potentially hazardous situation which, if not avoided, may result in serious injury or death.
	CAUTION : Indicates a potentially hazardous situation which, if not avoided, may result in minor or moderate injury.

Disclaimer

This equipment has been tested and found to comply with the limits for a Class A digital device, pursuant to part 15 of the FCC Rules. These limits are designated to provide reasonable protection against harmful interference when the equipment is operated in a commercial environment. This equipment generates, uses, and can radiate radio frequency energy and, if not installed and used in accordance with the instruction manual, may cause harmful interference to radio communications. Operation of this equipment in a residential area is likely to cause harmful interference, in which case the user will be required to correct the interference at his own expense.

Instructions contained in this user's guide should be performed only by qualified persons in accordance with local and national codes. Blue Ridge Technologies International, LLC and its affiliates assume no responsibility for any consequences related to the improper use of this manual.

Overview : Document

This document provides mounting and connection instructions for the following Blue Ridge Technologies Retrofit Kit (RK) products:

Retrofit Kit 2 (RK2)

RK2 is compatible with Douglas Panels (WR-6221, 6161, 6162, 6172, 6321) and ILC Panels (2PC).

Sections of this Install Guide apply to optional equipment and may not be applicable. See the Optional Equipment section for details.

Siemens' P1 and Automated Logic Corporation's BACnet ARCnet protocols are only available to authorized integrators.

For RK integration with a Building Automation System (BAS) as well as software configuration refer to the Application Guide.

Overview : Component

The RK2 includes the following items :

- 1 - Controller
- 2 - Relay Interface Boards (RIB-A) with (16) Relay Outputs
- 2 - Relay Interface Boards (RIB-B) with (16) Relay Outputs
- 2 - 16-20pin Ribbon Cables
- 2 - 16pin Ribbon Cables
- 1 - BT485 BAS Network Terminator (BT485 Terminator)

Overview : Assembly

- 1. Mounting Fastener Point
- 2. Mounting Plate
- 3. Controller
- 4. RIB

RIB Identification

- 5. RIB-A (Outside Ribbon Cable Socket)
- 6. RIB-B (Inside Ribbon Cable Socket)

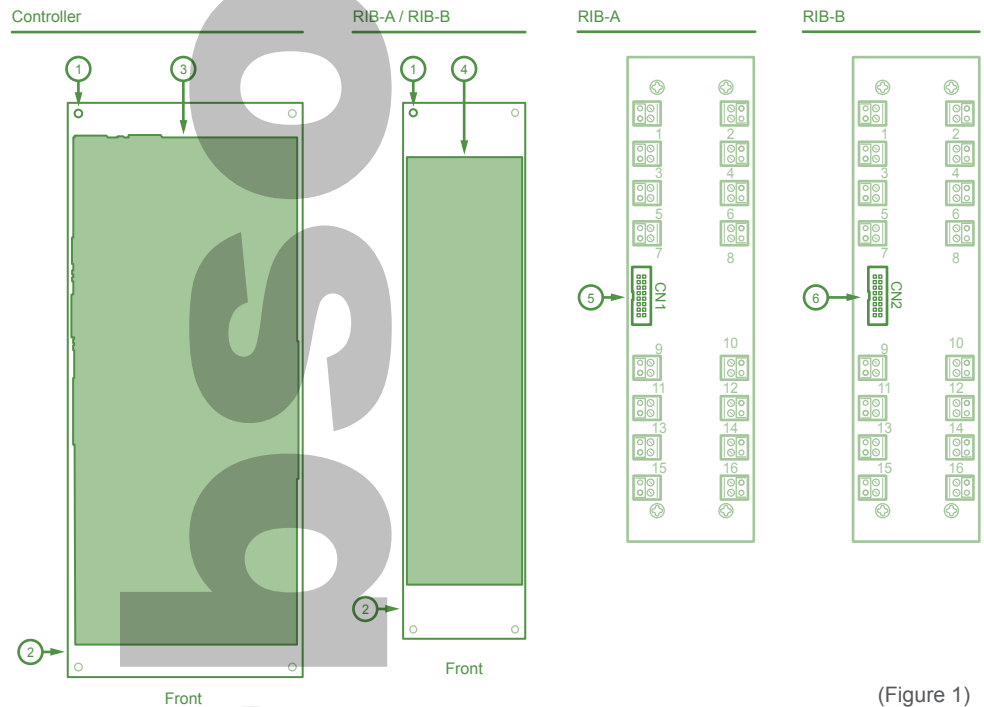

(Figure 1)



Disconnect line voltage power before performing RK installation.



All circuits must be tested for wiring errors and shorts prior to RK installation.

Before handling any RK components, the technician should be grounded to prevent circuit board damage.

DO NOT apply control power to the RK Relay Outputs. Remove any power source from the control side of the relays prior to RK installation.

Overview : Dimensions

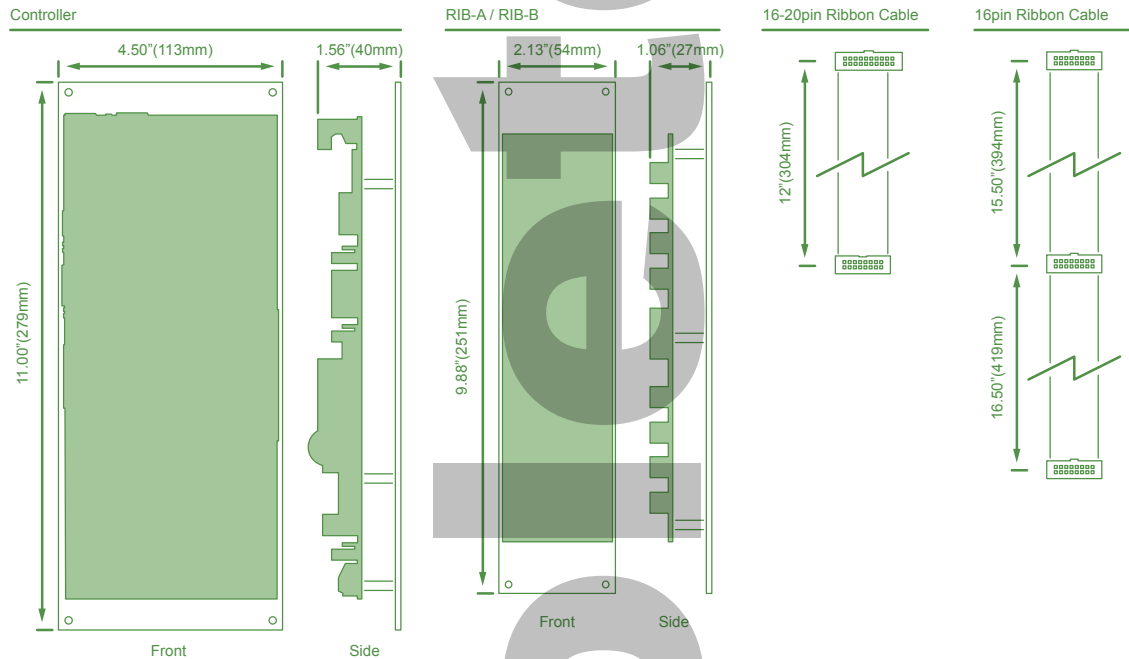

(Figure 2)

Preparation

Remove the existing control system.

1. Disconnect power from the panel.
2. Label all low voltage leads.
3. Unfasten or cut existing low voltage leads. Do not cut existing leads too short.
4. Unfasten and remove existing controller electronics. Remove any power source from the control side of the relays.
5. Remove any dust or debris from low voltage bay of the panel.

Mounting

Grouping Strategy

Retrofit Kits permit soft-wiring Inputs to Relay Outputs. This allows relays to be connected to any Relay Output terminal on the RIB while maintaining the original system configuration. Soft-wiring is achieved by a software based Grouping method. The Input (switches, occupancy sensors, etc) is assigned control of a Group. Each Group contains Relay Outputs (relays and related lighting circuits). Therefore, an Input commands its assigned Group and all the Relay Outputs contained within that Group. These Group assignments may be configured to suit any application ensuring maximum flexibility during physical installation. Connections may be recorded utilizing the RK Configuration Worksheet. (See page 10)

Example:

Original Configuration

- Input 1 controls Relay 1

Retrofit Configuration

- Due to panel arrangement Relay 1 is in close proximity to Relay Output 17 on RIB-B
- Therefore Relay 1 is connected to Relay Output 17.
- During software configuration Input 1 is assigned control of Group 1 and Relay Output 17 is placed in Group 1.
- The original configuration is maintained. Input 1 controls Relay 1 through Group 1.

Determine position of all components prior to installation. Consider these factors during this process.

- Ensure the all RIB's are near the relays with which they will interface.
- RIB position should minimize cross-board wiring (relay control leads lying across boards).
- Ensure Controller is near the power, input, and network leads.
- Confirm the distance between the Controller, RIB's, and Optional Equipment does not exceed the length of the ribbon cables.
- Allow a minimum of 0.75" (20mm) clearance between component mounting plates for ease of wiring.

The Retrofit Kit may now be mounted in the low voltage bay.

1. Confirm power is disconnected from the panel.
2. Fasten the Controller in position utilizing self-tapping screws. Drive a screw through each Mounting Fastener Point. Keep the board clear of any metal shavings. (Figure 1)
3. Repeat fastening procedure for each component required in the application.
4. Remove any metal shavings from the panel.

Connection

All low voltage leads are terminated on the Controller and RIB's. These screw terminals accept a 0.4 x 2.5mm slot head screw driver. (Figure 3)

1. Confirm power is disconnected from the panel.
2. Complete ribbon cable terminations to connect Controller, RIB's, and Optional Equipment. Disconnect power to the Controller before installing or removing ribbon cables. Failure to do so could result in damage to the electronics.
 - a. Route cables in a neat fashion to prevent interference during remaining installation.
 - b. Connect the 16-20pin Ribbon Cables to the Controller.
 - c. Connect the 16pin Ribbon Cables to the 16-20pin Ribbon Cables.
 - d. Connect one RIB-A and one RIB-B per 16pin Ribbon Cable. Do not combine like RIB styles on a ribbon cable. The sequence of RIB-A and RIB-B per ribbon cable is not specific.
3. Connect the relay control leads to the RIB's Relay Output terminal blocks. DO NOT apply control power to the RK Relay Outputs. Remove any power source from the control side of the relays.
 - a. Route leads.
 - b. Cut to length and strip as appropriate.
 - c. Insert stripped lead into screw terminal and tighten screw. Confirm the connection's orientation. (Figure 4)
 - d. Repeat procedure for each relay.
4. Connect existing power, input, and network leads to the Controller.
 - a. Route leads.
 - b. Cut to length and strip as appropriate.
 - c. Insert stripped lead into screw terminal and tighten screw.
 - d. Repeat for each lead.

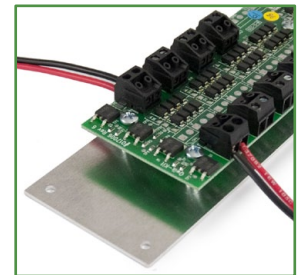
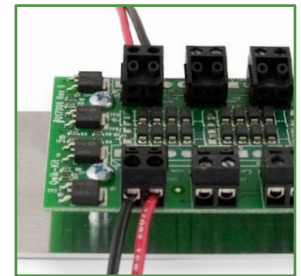
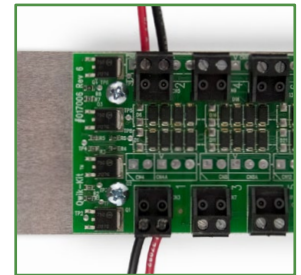
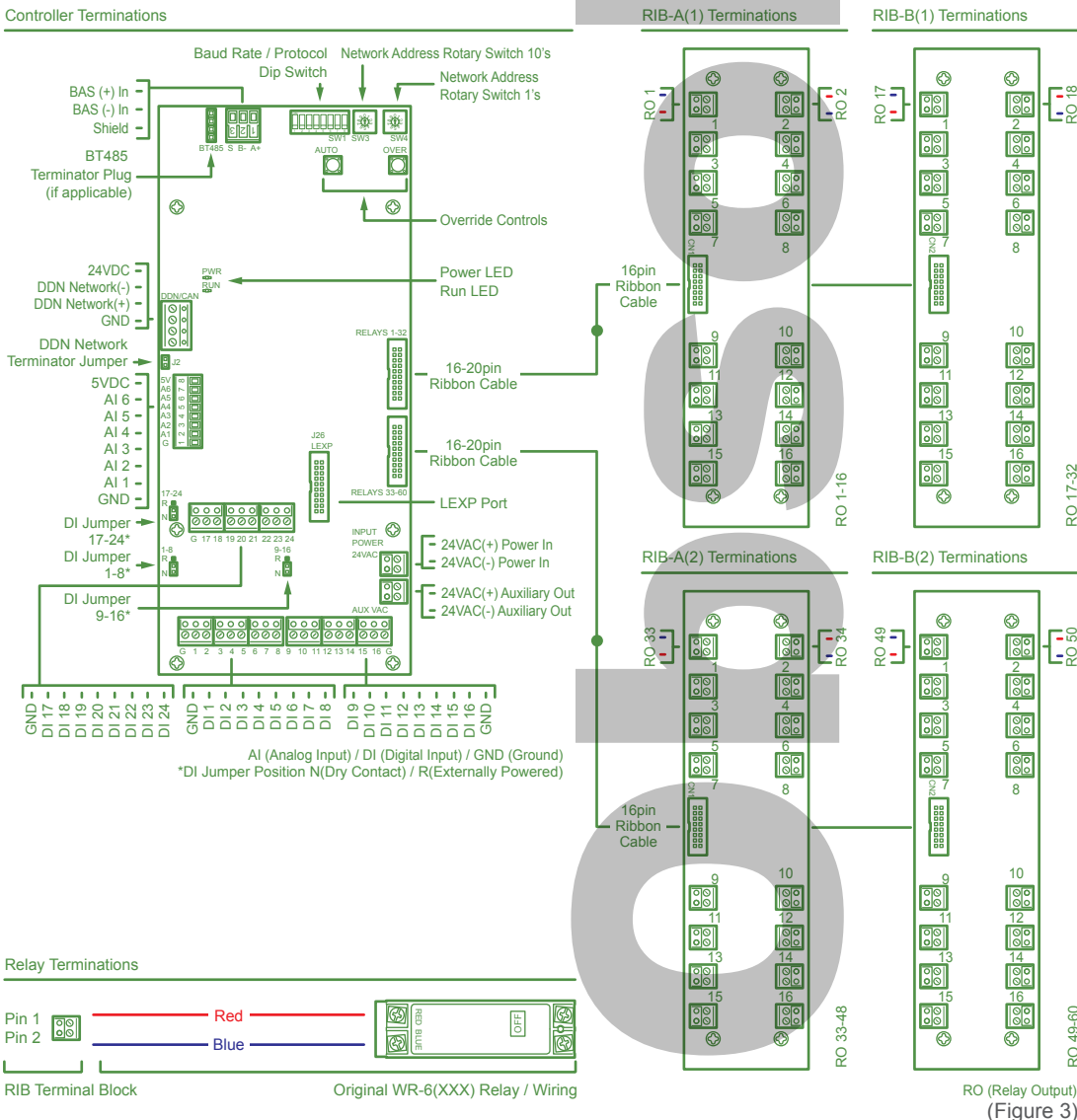

(Figure 4)

RO (Relay Output)
(Figure 3)

Connection

Power Specifications (Figure 5)

Power In: 24VAC +/-10%, 30VA, 50-60 Hz
Auxiliary Out: 24VAC Full Wave Rectified

Digital Input Specifications (Figure 6)

Digital Input: 24 two-wire inputs
Software Configuration: Maintained, state change, momentary on/off, momentary on, or momentary off
Jumper Configuration: 8 input segments, dry contact (N) or 24VDC externally powered (R)
Wire Requirement / Maximum Length: 18AWG (Solid or Stranded) / Dry Contact 500'(152m) or externally powered 1,000'(304m)

Power In: 24VAC

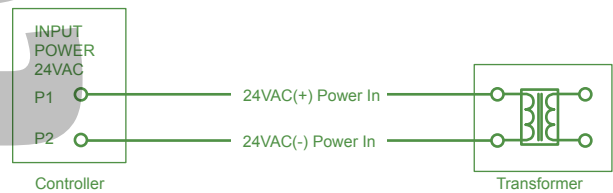

(Figure 5)

Digital Input: Two Button Low Voltage Switch (Dry Contact)



Digital Input: Two Button Low Voltage Switch (Externally Powered)

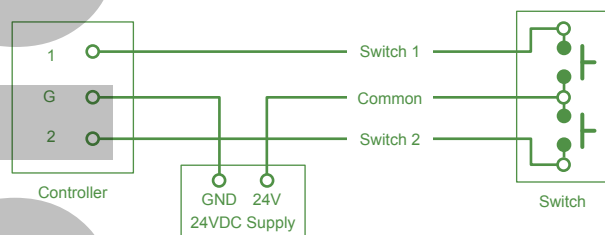

Digital Input: 4-Wire 24VDC Occupancy Sensor (Dry Contact)

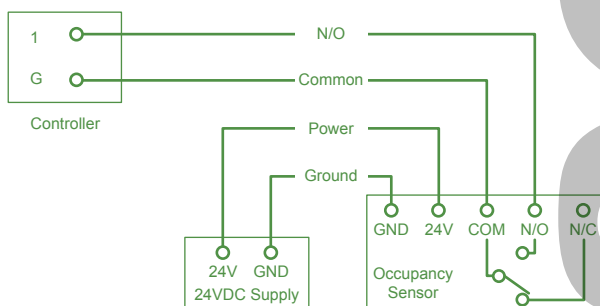

(Figure 6)

Digital Input Special Case (Figure 7)

Douglas WR8501-88 and equivalent switches may be configured to operate with RK2. This configuration eliminates the external power supply and green LED while maintaining the red LED as a pilot light.

Digital Input: Douglas WR8501-88 or equivalent (Dry Contact)

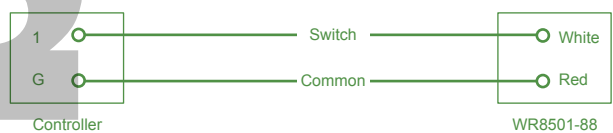

(Figure 7)

Analog Input Specifications (Figure 8)

Analog Input: 6 three-wire 0-5VDC inputs
Wire Requirement / Maximum Length: 18AWG (Solid or Stranded) / 250'(76m)

Analog Input: 5VDC Light Sensor

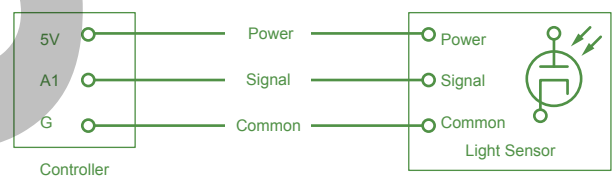

(Figure 8)

Terminations : Low Voltage

BAS Network Specifications

Topology: RS-485, 3 conductor (+, -, and shield), daisy chain wiring (no stars or t-taps)

Wire Requirement / Maximum Length: Belden 8760 / 4000'(1216m)

BACnet MS/TP

Baud Rate: DIP switch selectable 9.6K, 19.2K, 38.4K, or 76.8K

Device Profile: BACnet Advance Application Controller (AAC)

Address Range: 1 – 99 selectable with rotary dials

Unit Load: Full unit load, 32 devices per MS/TP segment

Points: See Application Guide and PIC Statement

N2

Baud Rate: DIP switch selectable 9.6K

Address Range: 1 – 255 selectable with rotary dials and DIP switch

P1

Baud Rate: DIP switch selectable 4.8K, 9.6K, 19.2K, or 38.4K

Address Range: 1 – 99 selectable with rotary dials

See Automated Logic Corporation's *ARC156 Wiring Technical Instructions* for the latest BACnet ARCnet specifications.

Install BT485 Terminator if RP is operated as end of line device (first or last device on network). BT485 Terminator requires no specific orientation in relation to the terminal.

See Controller Setup for Address and Protocol settings.

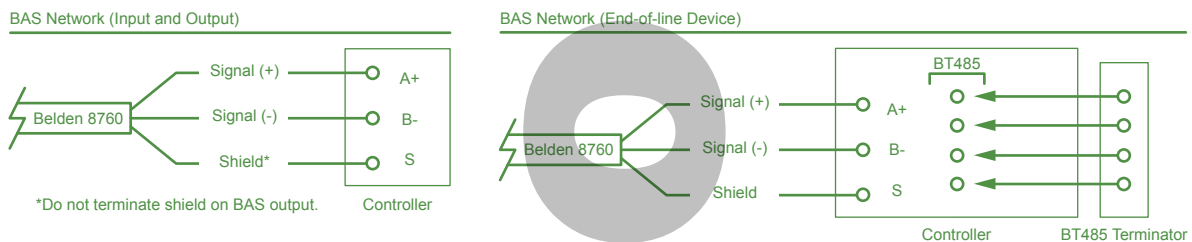

(Figure 9)

DDN Network Specifications

Protocol: Digital Device Network (DDN)

Address Range: 1-60, DIP switch selectable

Topology: Daisy Chain Wiring (no stars or t-taps)

Wire Requirement: CL3P, 22AWG, 4 conductor, Unshielded

Maximum Stations (w/o external power): 10 CTS-DDN

Maximum Length (w/o external power): 500'(152m)

Maximum Stations (w/ external power): 60 one-button, 30 two-button, or a combination for 60 buttons total

Maximum Length (w/ external power): 2,000'(610m)

Power / Draw: 24VDC / 15mA per CTS-DDN

DDN Network: CTS-DDN

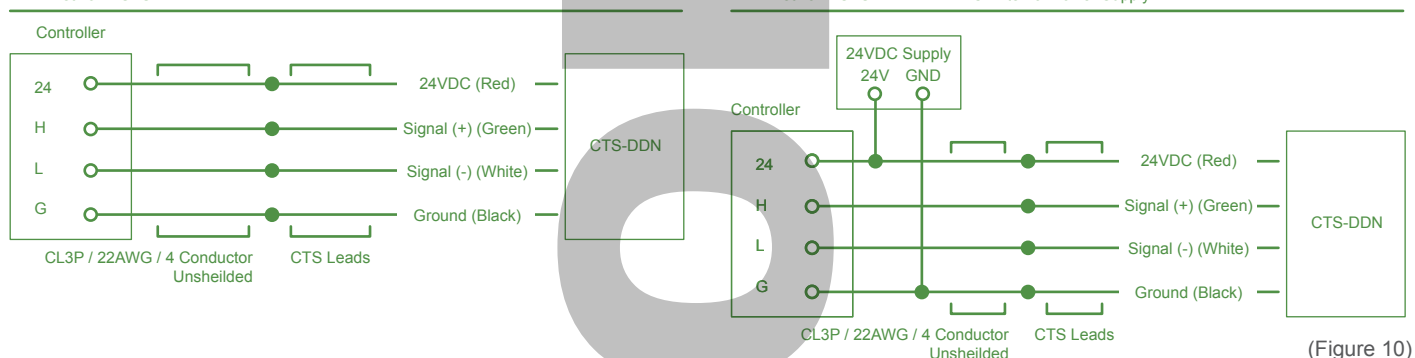

(Figure 10)

Controller Setup

Controller configuration and RK testing are the final steps of installation. (Figure 11)

Setup

1. Confirm power is disconnected from the Controller and the Power / Run LED's are not illuminated.
2. Set the DDN Network Terminator Jumper if utilizing DDN Network. Two devices on the DDN Network should be set for network termination. If the Controller is the end-of-line, terminate the Controller and the device at the opposite end of the network. If the Controller is positioned at a mid-point on the network, terminate devices at the opposite ends of the network either side of the Controller.
3. Set the Digital Input (DI) Jumpers.
4. Set the Baud Rate / Protocol Dip Switch for protocol and baud rate.
5. Set the Network Address.

Testing

1. Connect power to the Controller. Wait 10 seconds for power up.
2. Confirm normal LED operation.
Power LED: Solid illumination
Run LED: Continuous blinking
3. Press and release the Over Button. Confirm the Relays change state On/Off.
4. Press and release the Over Button again. Confirm the Relays change state On/Off.
5. Press and release the Auto Button to exit override mode.
6. Test procedure complete.

Controller Terminations

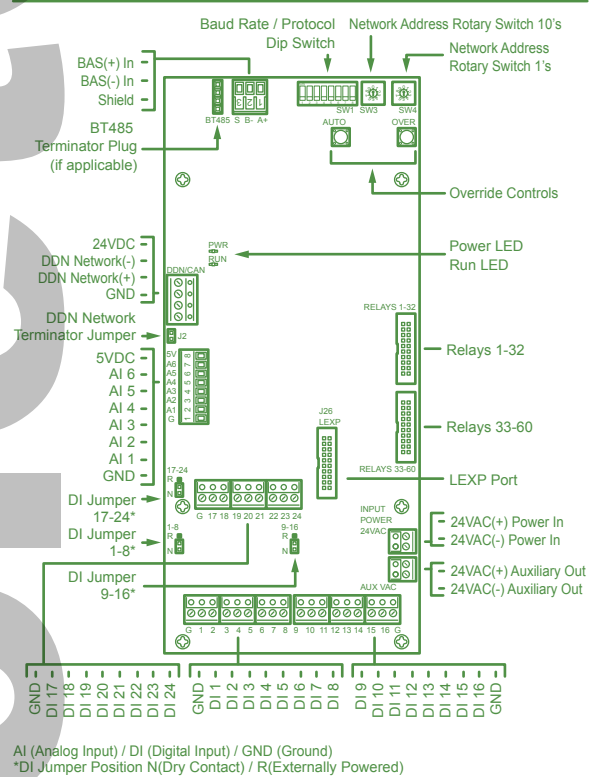

Network Address

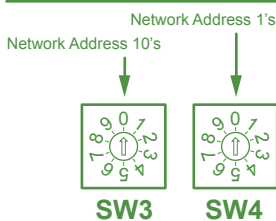

See right for N2 addresses 100-255

Digital Input (DI) Jumper

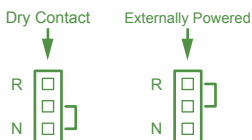

DDN Network Terminator Jumper

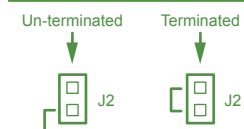

Baud Rate / Protocol Dip Switch: BACnet MS/TP

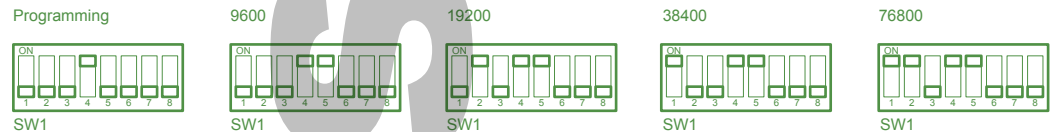

Baud Rate / Protocol Dip Switch: N2

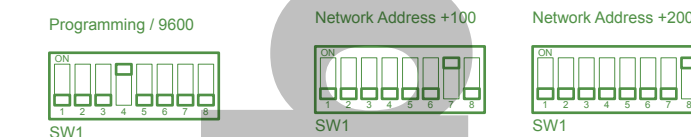

Baud Rate / Protocol Dip Switch: P1

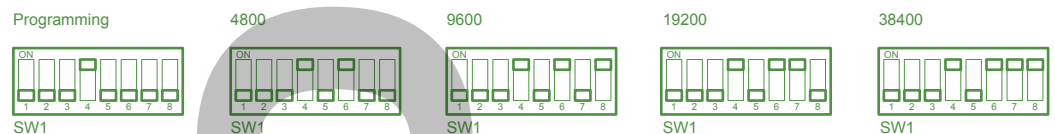

Baud Rate / Protocol Dip Switch: BACnet ARCnet

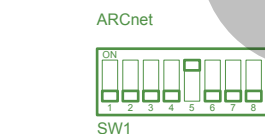

(Figure 11)

Optional Equipment

LEXP Specifications (Figure 12)

Description: Digital Input Expansion Card

Digital Input: 32 two-wire inputs

Software Configuration: Maintained, state change, momentary on/off, momentary on, or momentary off

Jumper Configuration: 8 input segments, dry contact (N) or 24VDC externally powered (R)

Wire Requirement / Maximum Length: 18AWG (Solid or Stranded) / Dry Contact 500'(152m) or externally powered 1,000'(304m)

Dimensions: 6.00"(152mm)H x 4.50"(113mm)W x 1.13"(29mm)D

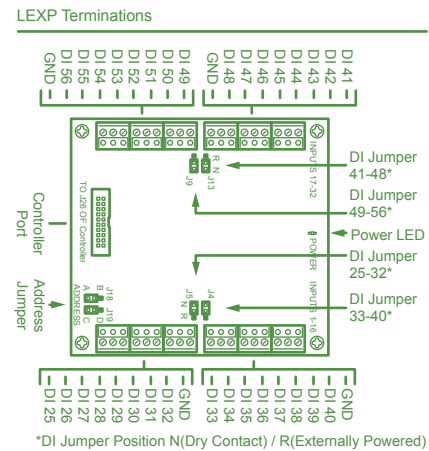

(Figure 12)



RK Configuration Worksheet RIB-A (1)

RIB Terminal Number (Relay Output)	Original Relay Number	Area Controlled	Original Input Number
1(1)			
2(2)			
3(3)			
4(4)			
5(5)			
6(6)			
7(7)			
8(8)			
9(9)			
10(10)			
11(11)			
12(12)			
13(13)			
14(14)			
15(15)			
16(16)			

RIB-B (1)

RIB Terminal Number (Relay Output)	Original Relay Number	Area Controlled	Original Input Number
1(17)			
2(18)			
3(19)			
4(20)			
5(21)			
6(22)			
7(23)			
8(24)			
9(25)			
10(26)			
11(27)			
12(28)			
13(29)			
14(30)			
15(31)			
16(32)			



RK Configuration Worksheet RIB-A (2)

RIB Terminal Number (Relay Output)	Original Relay Number	Area Controlled	Original Input Number
1(33)			
2(34)			
3(35)			
4(36)			
5(37)			
6(38)			
7(39)			
8(40)			
9(41)			
10(42)			
11(43)			
12(44)			
13(45)			
14(46)			
15(47)			
16(48)			

RIB-B (2)

RIB Terminal Number (Relay Output)	Original Relay Number	Area Controlled	Original Input Number
1(49)			
2(50)			
3(51)			
4(52)			
5(53)			
6(54)			
7(55)			
8(56)			
9(57)			
10(58)			
11(59)			
12(60)			