

RCS1000 Install Guide



TRIA TEK[®] LIGHTING
THE NEW STANDARD IN LIGHTING CONTROLS

For:
RCS-FM
RCS-RM



Includes:
RCS1000 Quick Install Guide
RCS-FM Installation Guide
RCS-RM Installation Guide

ATTENTION

This section serves as a notice of the immediate or potential dangers involved when working with the equipment described throughout this manual. Any person involved in installation, maintenance, or service of the equipment should first carefully examine the equipment and read the instructions contained in this manual to ensure that personal and/or equipment injury is avoided.

The following safety messages are used throughout this manual to alert of immediate or potential danger to life or property:



Hint Indicates a tip or trick to help you.



Note Indicates an important note.



DANGER! Indicates an immediately hazardous situation which, if not avoided, will result in death or serious injury.



WARNING! Indicates a potentially hazardous situation which, if not avoided, can result in death or serious injury.



CAUTION: Indicates a potentially hazardous situation which, if not avoided, can result in minor or moderate injury.

CAUTION: Used without the safety alert symbol, indicates a potentially hazardous situation which, if not avoided, can result in personal or property damage. Failure to comply with proper handling of the TRIATEK Lighting products may void your warranty



In addition, this symbol may appear in the margin of specific portions of text as a safety reminder. Applicable instruction steps will be listed beneath the symbol.

Disclaimer

This equipment has been tested and found to comply with the limits for a Class A digital device, pursuant to part 15 of the FCC Rules. These limits are designated to provide reasonable protection against harmful interference when the equipment is operated in a commercial environment. This equipment generates, uses, and can radiate radio frequency energy and, if not installed and used in accordance with the instruction manual, may cause harmful interference to radio communications. Operation of this equipment in a residential area is likely to cause harmful interference, in which case the user will be required to correct the interference at his own expense.

Instructions contained in this user's guide should be performed only by qualified persons in accordance with local and national codes. TRIATEK® Lighting and its affiliates assume no responsibility for any consequences related to the improper use of this manual.

Contents

RCS1000 Installation Guide

<i>RCS1000 Installation Guide Overview</i>	4-6
Introduction	4
Controller to Breaker Panel Mounting Configurations	5
Wiring Applications	5-6
<i>RCS1000 Quick Installation Guide</i>	7-11
RCS-FM	7
RCS-RM	8-11
<i>Installing RCS1000 with RCS-FM</i>	12-16
Connecting Switch Inputs and Communication Network	13-16
Connecting the RCS-LMB Controller Switch Inputs	13-14
Connecting Expansion Board Switch Inputs	14-15
Connecting the RCS1000 RS-485 Network	15-16
<i>Installing RCS1000 with RCS-RM</i>	17-30
Installing the Breaker Panel Enclosure	17
Installing the Interior	17-18
Installing the RCS-RM	18-22
Wiring the RCS-RM	22-25
Upgrading RCS1000	25-30
Installing Additional Breakers	25-26
Installing the Switch Expansion Board	27
Installing the DDN-L Module	27-30
Installing the LS5 Photo Cell	31
<i>Appendix A:</i>	
Measurements for Placement of Connection Holes	32
<i>Appendix B:</i>	
Power Supply Quick Connect of Transformer to Fuse	33

RCS1000 Installation Guide Overview

Introduction

This installation guide gives instructions on how to install TRIA TEK® Lighting's RCS1000 Series Programmable Circuit Breaker Panel. The guide contains four major sections: an overview, a quick install guide, and two detailed RCS-FM and RCS-RM Installation Guides. Installers experienced with installing controllable breaker panels may primarily use the quick install guide and use the more detailed guides as reference. Two referenced appendices are included at the end of the document.

As implied already, the RCS1000 comes in two configurations: RCS-FM and RCS-RM. The RCS-FM is a complete factory assembled unit, and the RCS-RM is sold and shipped as separate components. Both models of the RCS1000 can be installed for either flush or surface mount applications.

The RCS1000 Series Programmable Circuit Breaker Panels have two major parts: a circuit breaker panel with remote control circuit breakers and a controller that provides all system features plus control of each circuit breaker. (Features and programming of the LP Controller are not covered in this user guide. Refer to the "LP Controller Users Guide" on TRIA TEK® Lighting's website.) For detailed parts and availability information refer to the RCS1000 Data Sheet on the website.

The RCS1000 Series Programmable Circuit Breaker Panel is composed of six basic components (numbered arrows below are defined here):

- (1) Galvanized steel circuit breaker enclosure
- (2) 18, 30, or 42 circuit breaker copper interior (various ampacity and main breaker sizes),
- (3) Controller (controls up to 60 circuit breakers so one controller can control multiple circuit breaker panels.
- (4) Bolt-on Remote Control Circuit Breakers (single and double pole, 15, 20, or 30 amp),
- (5) Painted door and trim
- (6) Low voltage control wiring from controller to each remote control circuit breaker.

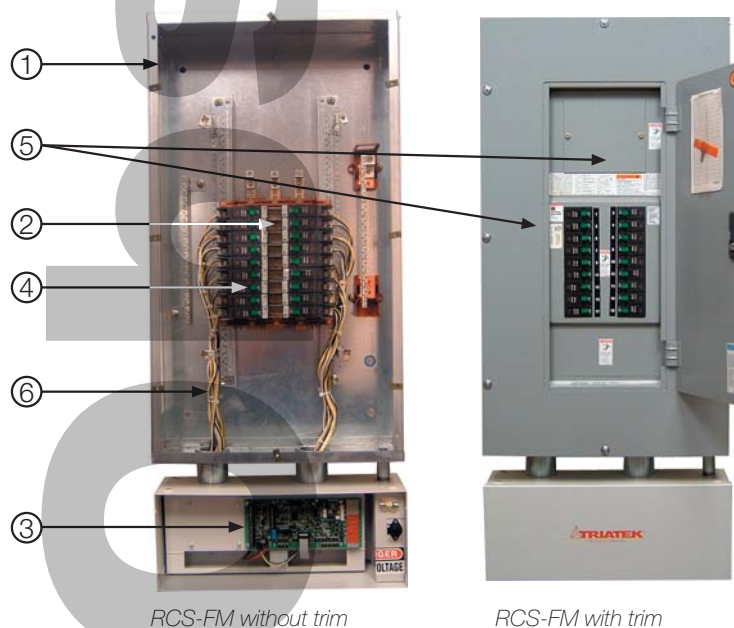

Controller to Breaker Panel Mounting Configurations

The RCS-FM has two possible configurations based on feed (Refer to the data sheet for ordering details). The controller is mounted on the opposite end of the feed:

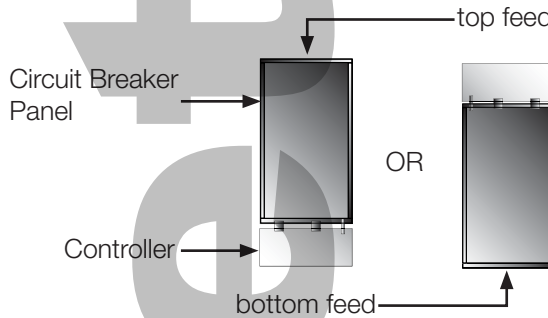

Because the RCS-RM is field mounted, it has three configurations involving mounting the controller to the breaker panel. The controller can be mounted to either the left or right side, or it can be mounted remotely:

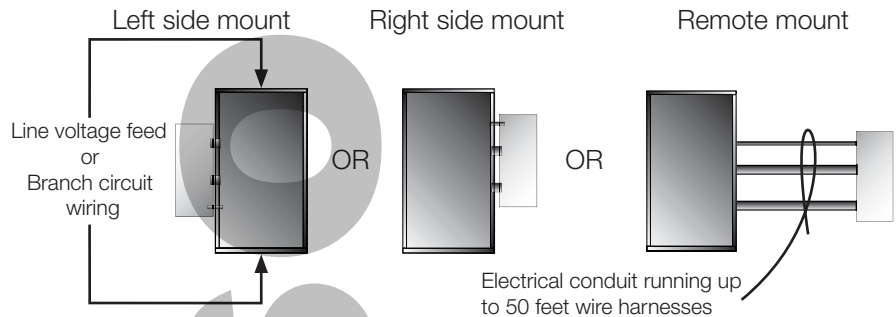

All three configurations allow line voltage and branch circuit wires to be run through the top or bottom separately. Remote mounting grants remote control when space is limited and the controller cannot be mounted to the breaker panel.

The diagrams show the different ways an RCS1000 can be configured by mounting a controller to a single breaker panel. The next section shows the wiring involved in these configurations, and how they can be expanded include to multiple breaker panels.

Wiring Applications

The RCS1000 Controller can control up to 60 programmable circuit breakers. Since a breaker panel can contain a maximum of 42 poles, the capability to control 60 breakers implies that an RCS controller can be wired to multiple breaker panels. For example, one controller could control one panel containing 42 one pole circuit breakers and another with 18 one pole breakers. The following diagram demonstrates this capability with three wiring applications of RCS-FM and the RCS-RM.

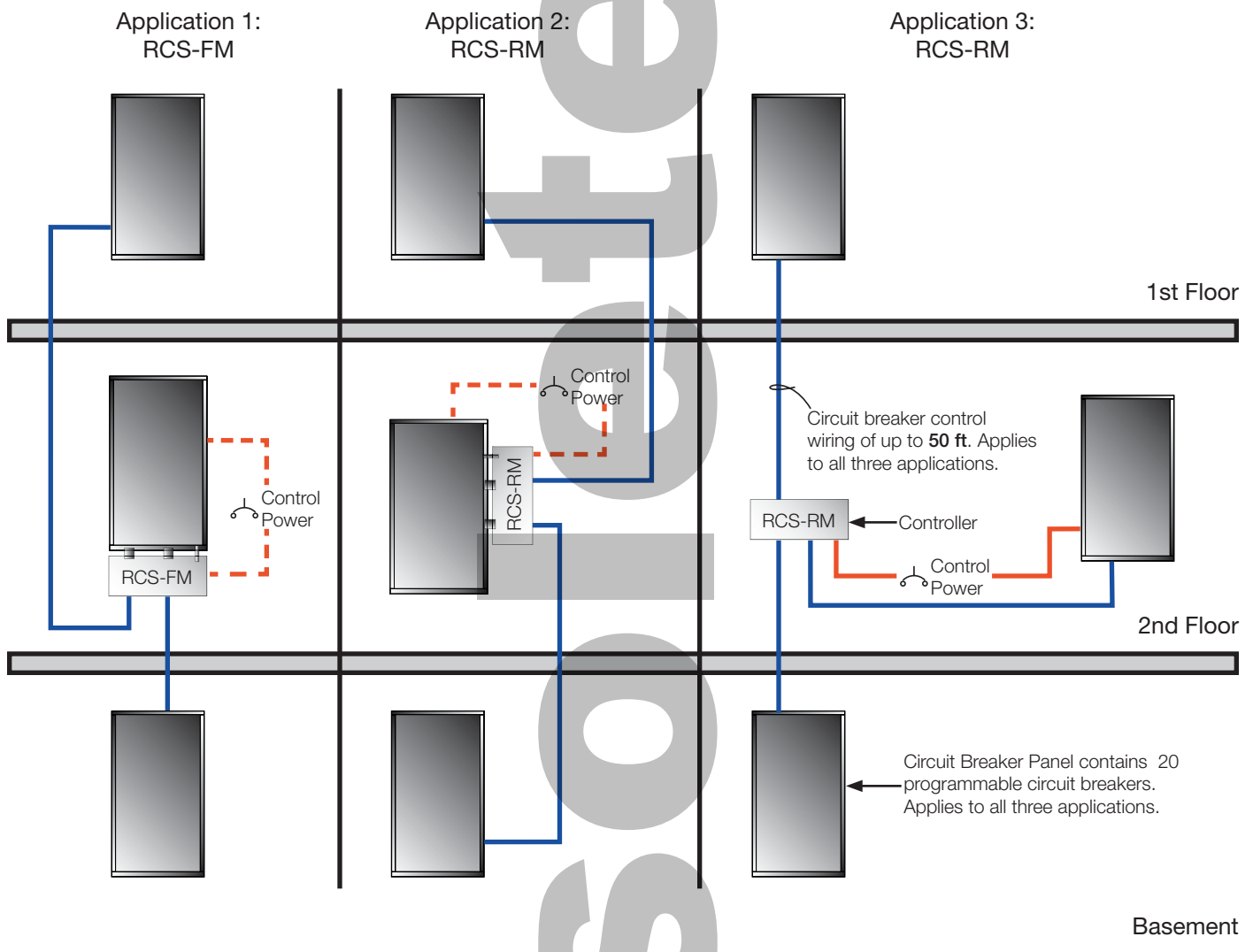

Application 1 demonstrates how an RCS-FM can control multiple breaker panels. Application 2 demonstrates the same for an RCS-RM with the controller directly mounted on one of the sides of the breaker panel enclosure. In all three applications the controller draws power from a single standard (non-controllable) circuit breaker within a single circuit breaker panel. Since Applications 1 and 2 have the controller directly mounted to a circuit breaker panel, the power for the RCS controller would be run through the connecting hardware and into the circuit breaker panel to which it is connected. There would be no need for an external control power wire as with Application 3; the control power line is dashed for this reason. In Application 3 the controller is mounted remotely from all breaker panels it controls. As with the circuit breaker control wiring, the controller power wires will need to be run externally to a breaker panel receive its power.

Also, observe the location of outgoing circuit breaker control and power wire runs from the controller. Circuit breaker control wires (within conduit) should be run only from either the top or bottom face of the controller. Control power wires should be run only from the top, bottom and side within the high voltage warning cover of the controller's transformer. Refer to "Installing the RCS-RM" and "Wiring the RCS-RM" on pages 18-25 for details.

Quick Install Guide

RCS-FM Quick Install

1. Remove the eight screws of circuit breaker enclosure door and remove the door, Remove the four screws of the dead front and remove the dead front.

- (A) RCS-FM as shipped with trim.
 (B) Trim removed; dead front exposed.
 (C) Trim and dead front removed.

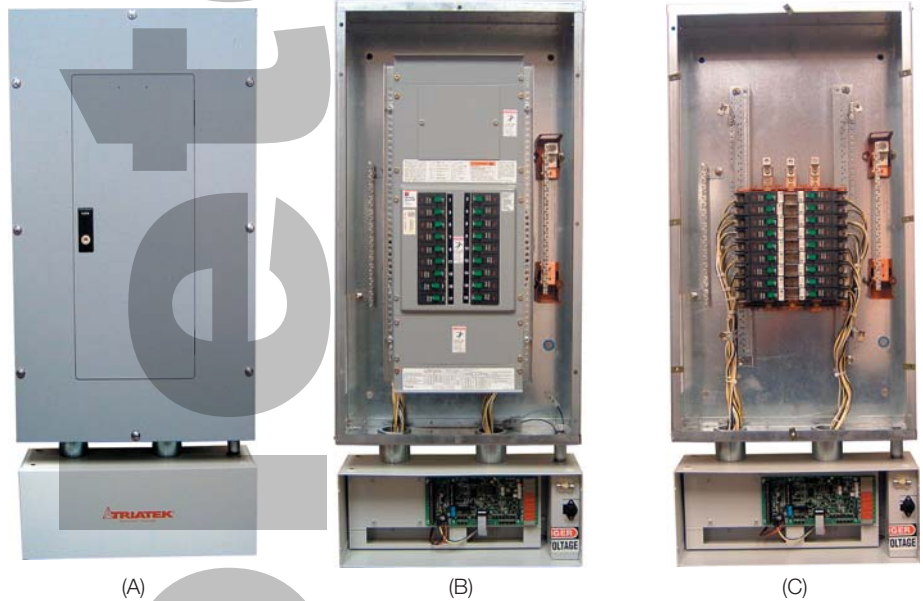

2. Drill and knock out holes for line voltage and branch circuit wires in proper feed location.
3. Mount the entire unit by using anchors/bolts rated to hold 150-200lbs at the four mounting holes in the breaker panel enclosure.



spade connector on voltage quick connect between transformer and fuse

4. Remove the four screws of the controller cover and remove the cover.
5. Ensure that proper voltage is connected from transformer to fuse. Refer to diagram in Appendix B, "Quick Connect of Transformer to Fuse of Power Supply."

6. Connect power supply for controller using either (1) a standard circuit breaker and neutral bar, or (2) a power panel.



CAUTION: Controller ships with dual coil transformer fused to 120 vould lead. To supply transformer with 277V, connect 277 transformer lead to the fuse holder and connect fuse holder lead to the branch circuit breaker. See page 33 for fusing detail.

7. Run all line and branch circuit wires and terminate onto the main breaker or lugs and circuit breakers respectively.

8. Replace trim for controller and panel enclosure.

RCS-RM Quick Install

1. Upon receiving the circuit breaker enclosure you will need to drill necessary holes for line wires, branch circuit wires, circuit breaker control wires, and for controller power wires.
2. Install the interior, with ground and neutral bars into the enclosure.

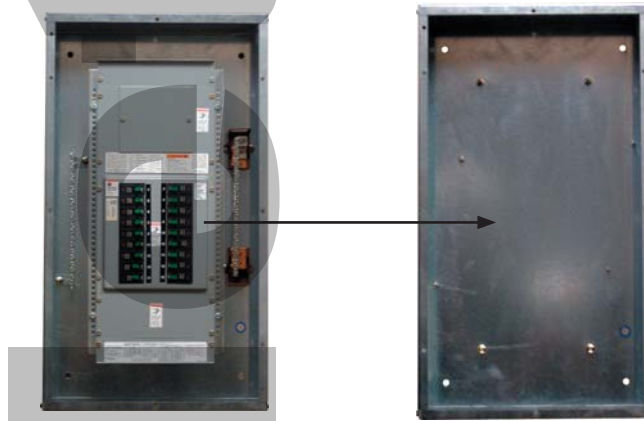

Remove interior from its shipped enclosure and install in the enclosure in which holes were made.

3. Mount the enclosure to the wall with appropriate anchors.
4. Remove controller backplane in order to remove controller with interface boards as shown below.

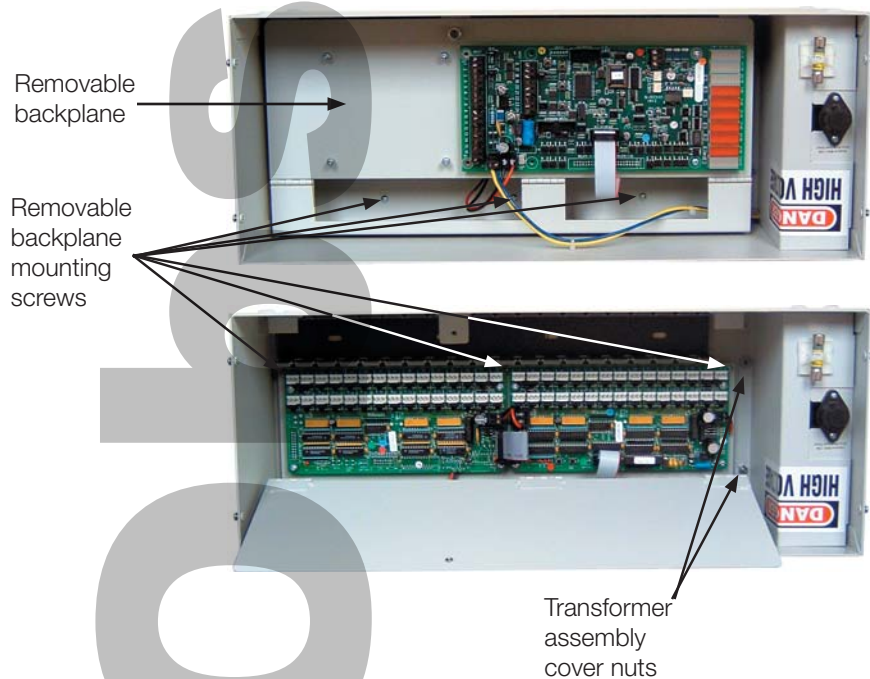

5. Drill holes in the controller enclosure for running circuit breaker control wires and power supply.

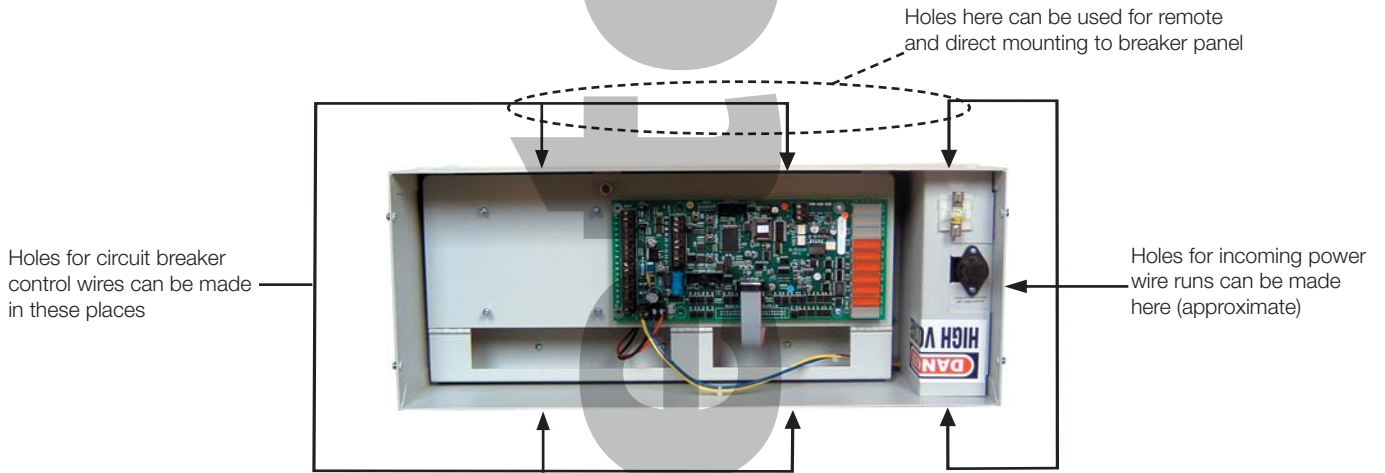

When connecting the controller directly to a side of a breaker panel use recommended hardware shown below (measurements included) to mount the controller to the breaker panel. Refer to Appendix A for exact drilling locations.

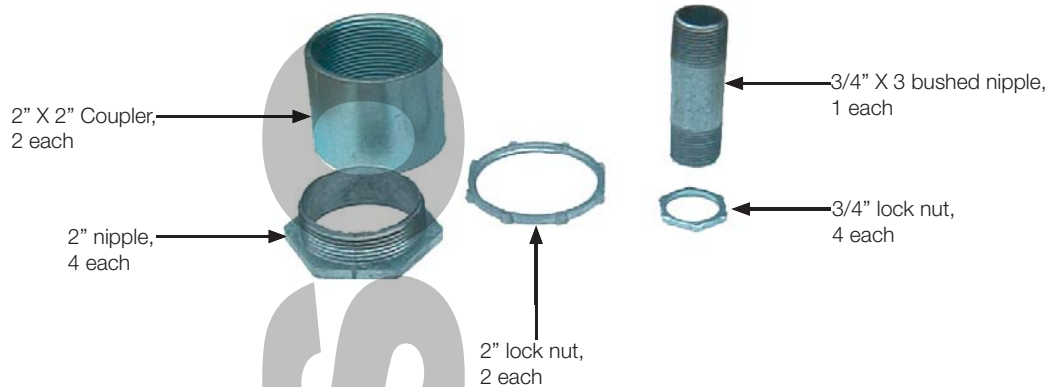

Example installation:

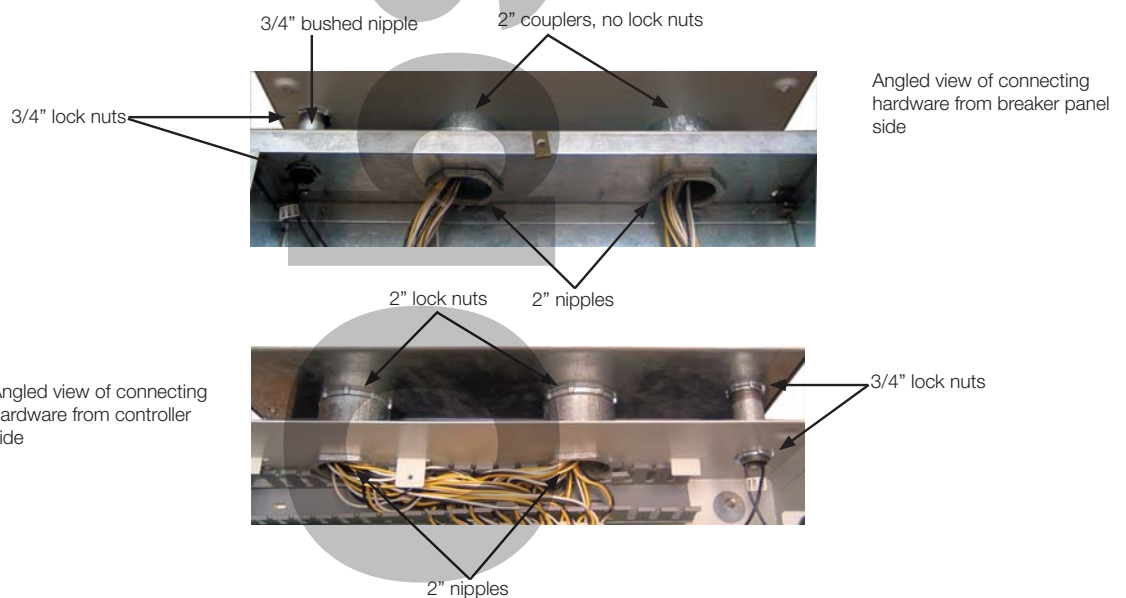

Note: If you are wiring a controller to a panel remotely, mount the controller to a wall and use conduit to run circuit breaker control wiring.

6. Reinstall backplane.

7. Obtain wire to make circuit breaker control harnesses. Circuit breaker control wires are not provided by TRIATEK® Lighting. Each harness requires three 20AWG stranded 600V insulation wires. TRIATEK® Lighting recommends white, yellow, and black color coding. TRIATEK Lighting recommends Belden #32720 or equivalent.

8. Measure, label, and cut circuit breaker control wires.

9. Crimp wires

(a) Load crimper as shown below.



(b) Crimp one end of wires in order of (1) white, (2) black, and (3) yellow. Insert wire and pull trigger. See below for loading examples.

Crimping the white wire.

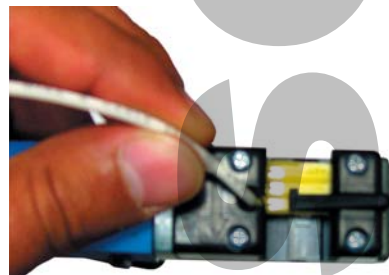

Crimping the black wire.

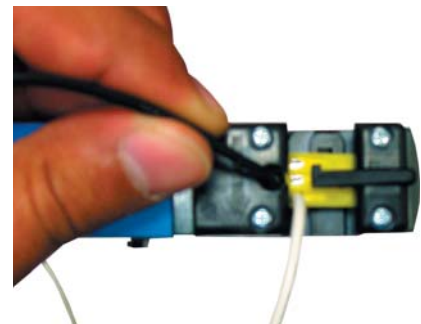

Properly terminated harness:

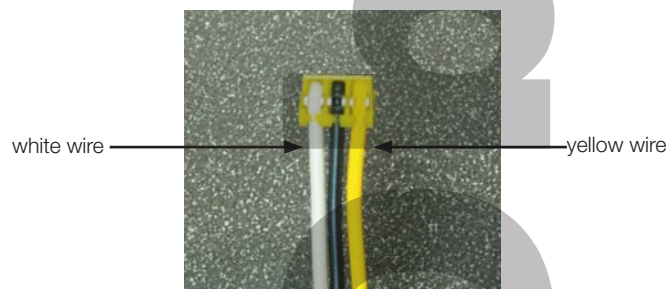

10. Install one end of harness with connector onto circuit breaker interface board, run the other end of the harness into circuit breaker panel. Odd breaker control wires will terminate on the left column of breakers, and the even breakers will terminate on the right column of breakers.

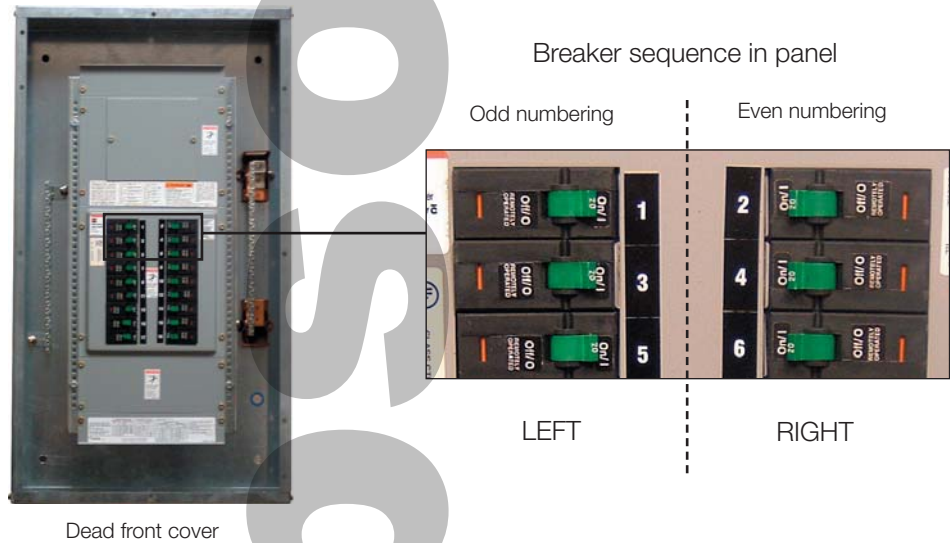
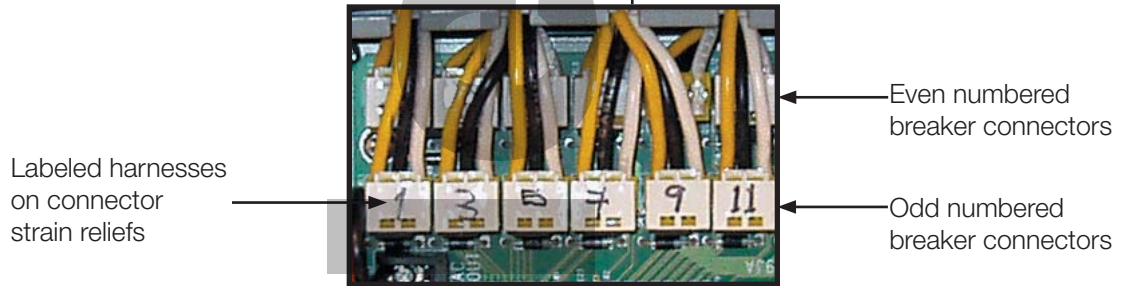
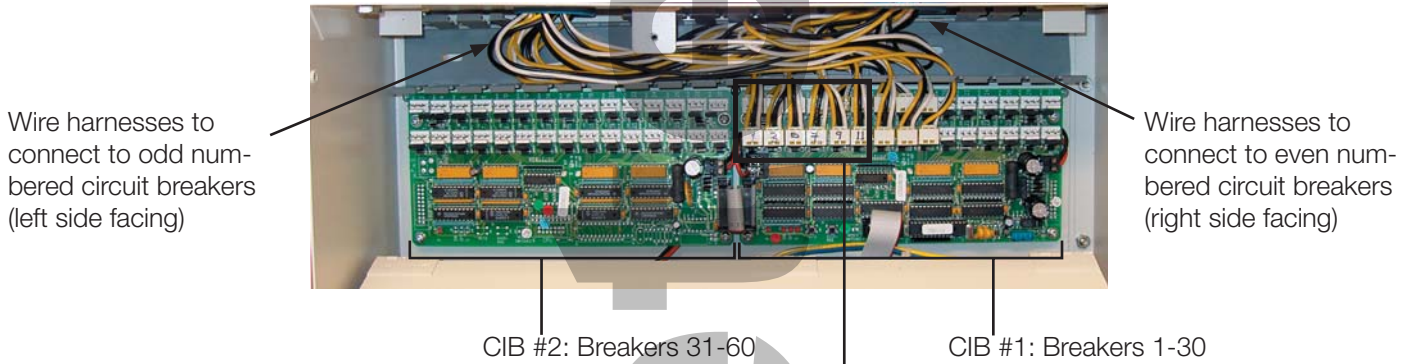

Connecting a harness to a breaker.

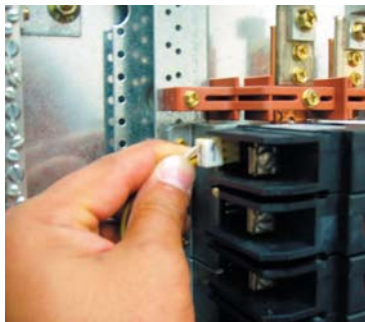

11. Connect harness to circuit breaker.
12. Repeat steps 7-10 for all circuit breakers.
13. Connect power supply for controller using either a standard circuit breaker and neutral bar, or use a power panel to supply power.
14. Run line voltage wires and branch circuit wires into breaker panel.
15. Install all trim.

Installing RCS-FM

Figure 1



RCS-FM shown as shipped

The RCS-FM is the factory assembled RCS. This unit comes completely pre-assembled according to customer specifications outlined in the data sheet (See RCS1000 Data sheet).

- 1. Unpack the unit and check for any visible damage that may have occurred during shipment.**
- 2. Remove the door covers for both the breaker panel and the controller.** The breaker panel door is attached with eight screws, one at the top and bottom and three on each side. The controller enclosure door is mounted with four screws, two on each side.
- 3. Mount the RCS1000 to the wall with the appropriate wall anchors.** Use wall anchors capable of supporting up to 150-200 pounds (42 circuit unit). The enclosures for both the circuit breaker panel and controller contain four mounting holes. The circuit breaker interior does not need to be removed to reach the four screw holes in its interior.
- 4. Drill necessary holes in the circuit breaker panel enclosure for line voltage and branch circuit wiring.** The controller comes pre-assembled in the FM configuration based on customer-provided feed specification (see "Mount" section under "Ordering Instructions for the RCS1000 with RCS-RM" in the RCS1000 data sheet). Based on line feed, the controller will be mounted on the top or bottom of the circuit breaker panel enclosure. Drill the holes for line voltage either directly above or below the main breaker or main lugs.



WARNING! Do not attempt to move or handle live line wires. Perform all precautionary safety procedures necessary before handling line voltage wires.

- 5. Pull and terminate all line voltage wires and circuit wires through the drilled holes made in Step 4.** All wiring should be in accordance with local regulations and the National Electric Code. To terminate line voltage, remove the breaker interior deadfront. The deadfront is fastened with four screws. Remount the deadfront when line voltage termination is complete.



Steps 6-7

- 6. Connect the low voltage power from the transformer (via slow blow fuse).** This can be accomplished by supplying power through a circuit breaker. Power can also be connected to an existing breaker in the panel that is non-controllable. Note: An extra standard (non-controllable) circuit breaker must be ordered. If power wires are connected to a controllable circuit breaker and that breaker is accidentally controlled to OFF, the controller will then lose power and all remote control of the RCS1000 will be lost.

To power the controller transformer from a circuit breaker, use 18AWG 600V insulated wire for the neutral wire and the hot wire. Connect the neutral wire to the neutral bar. Next, connect the voltage wire (either 120V or 277V - see caution below) to the branch circuit connector by unscrewing the connector plate, inserting the wire between the plate and the connector base, and retightening the screw.



CAUTION: Controller ships with dual coil transformer fused to 120 vold lead. To supply transformer with 277V, connect 277 transformer lead to the fuse holder and connect fuse holder lead to the branch circuit breaker. See page 33 for fusing detail.

7. Switch line power to the breaker panel. If the breaker panel is Main Lug Only (MLO), the controller board should now have power. The system status LED in the upper right hand corner of the board should be flashing. (See LP Controller Users Guide for operational details of the controller board.)

8. Reinstall the doors of the panels using the provided screws.

Connecting Switch Inputs and Communication Network

The following section of the installation guide discusses how to connect switch inputs to the RCS-LMB controller and the Expansion Module and how to connect the controller to a Building Automation System via an RS-485 twisted pair network. Instructions for connecting switch inputs for the Expansion module are included here due to similarity. (The Expansion Module should be installed before connecting switch inputs. Refer to the section, “Installing the Switch Input Expansion Module” under “Upgrading the RCS-RM” of this manual.)

Connecting RCS-LMB Controller Switch Inputs

The RCS-FM comes standard with 24 programmable switch input capacity. The 24 termination points are divided into three sections of eight, with each section containing one ground point (all three grounds are common). All points are numbered, and ground points are labeled “G”. *Do not apply AC voltage to any of the terminals.* Switch inputs location and labeling on the RCS-LMB are shown below.

Figure 2

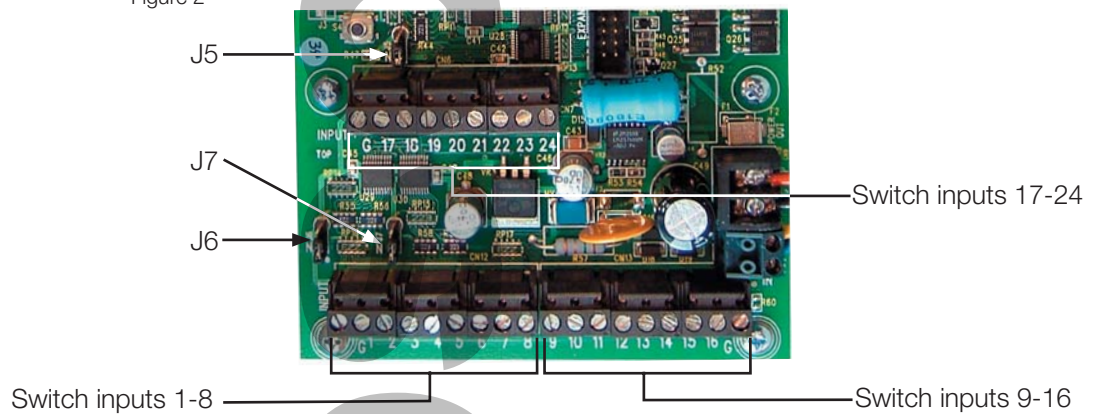

The inputs can be momentary on, momentary off, or momentary on/off, with either maintained dry contacts or up to 24VDC. Each section has an accompanying jumper that sets whether its associated eight inputs will be up to 24 VDC or dry (0 VDC). Figure 3 lists the switch inputs and associated jumpers.

Figure 4

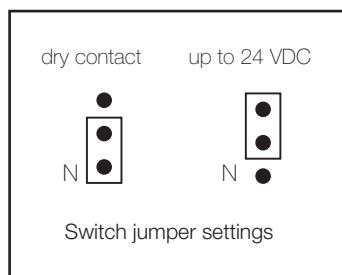

Figure 3

Switch Input Section	Associated Jumper
1- 8	J6
9-16	J7
17-24	J5

Each jumper set has 3 pins, one of which is labeled “N”. The “N” jumper is for setting the switch inputs for dry contact. The “up to 24” pin of the jumper pin is not labeled. Figure 4 shows how to place jumpers properly.

The jumper must be set before wiring. *If one switch input is dry, the entire section of eight switch inputs must also be dry contacts, and the associated jumper must be in the “dry” position. If one switch input is externally powered up to 24 VDC, the entire section of eight switch inputs must also be up to 24 VDC, and the associated jumper must be in the “up to 24” position.*

CAUTION: Before handling any components on the circuit board, the installer should be grounded to prevent damaging the board.

1. **Remove power to the controller.** Remove the yellow/blue power harness by lifting on its terminator block.
2. **Set jumpers.** See explanations and Figures 2-4 above.
3. **Connect the switches to the controller.** See wiring diagram for various input types. The switch input terminal blocks are screw type. Land wires by unscrewing, inserting the stripped wire, and tightening the screw.
3. **Reconnect power to the controller.**

Connecting Expansion Board Switch Inputs

Figure 5

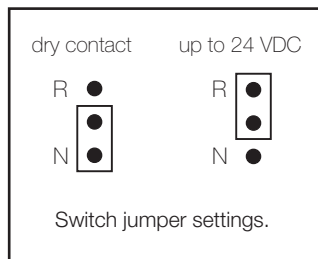

The expansion module contains 32 programmable switch inputs that are controlled in sections of eight as with the 24 switch inputs of the controller. Each section of eight switch inputs is set to either dry contact or up to 24 VDC with jumpers as well. On the expansion module the jumpers are labeled by the numbered range of switch inputs they control instead of by jumper number. For example, the jumper that sets switch inputs 1-8 is labeled “1-8.” Dry and up to 24 jumper positions are labeled “N” and “R”. Refer to Figure 5 for jumper details. The illustration below (Figure 6) indicates jumper location and labeling.

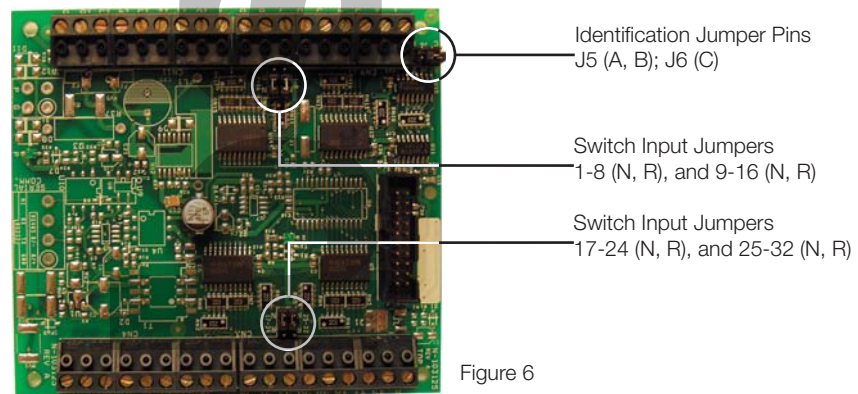

Figure 6 above also shows one more set of jumpers: jumpers labeled J5 (with positions A and B) and J6 (positions C and D). The RCS1000 can accept up to 120 programmable switch inputs, comprised of 24 from the controller and 3 X 32 from expansion boards. If more than one expansion card is used for additional switch inputs, the controller must be able to distinguish expansion boards. Therefore, A, B, C, D refer to board identification settings. If the expansion module is the first in series of expansion boards, then the jumper should be set to A. The second should be set to B, and so on. The installer should note that there is not a D module.

The maximum number of expansion boards possible is three. Do not attempt to install a fourth expansion board and set its jumper to D; the RCS controller will not recognize the inputs.



CAUTION: Before handling any components on the circuit board, the installer should be grounded.

1. **Remove power to the controller.** Remove the yellow/blue power harness by lifting on its terminator block.
2. **Set jumpers.** See explanations and Figures 5 and 6 above.
3. **Connect the switches to the expansion board.** The switch input terminal blocks are screw type. Land wires by unscrewing, inserting the stripped wire, and tightening screw.
3. **Reconnect power to the controller, as described above.**

Connecting the RCS1000 RS-485 Network

The RCS1000 is capable of being networked to a Building Automation System or Central Computer over a two or three wire RS-485 communication network. A terminal block is provided to connect the two communication wires plus the shield wire. (RS-485 wires are not provided by TRIATEK® Lighting.) Use 18 AWG stranded 600V insulated wire. The RS-485 connection location and labeling is illustrated in Figure 7.

Figure 7

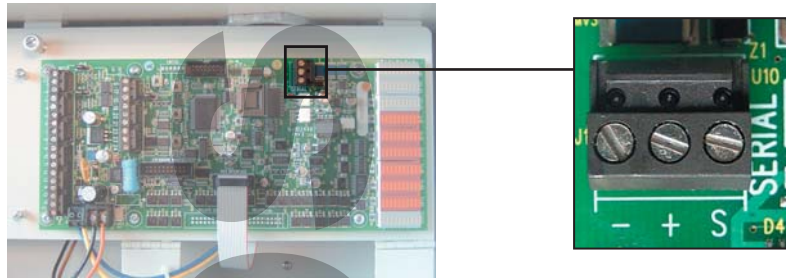

1. **Disconnect power to the RCS-LMB.**
2. **Connect incoming and outgoing transmit “+” to “+” on the RS-485 connector.** As with switch inputs, a screw type terminal block is provided.
3. **Connect incoming and outgoing transmit “-” to “-” on the RS-485 connector.**
4. **When a shield wire is used, either splice incoming and outgoing shield wires together or connect to “S” on the RS-485 connector.**
5. **Reconnect power to the RCS-LMB.**

Note: For information on operating components of and programming the RCS-LMB controller, refer to the “LP Controller Users Guide” available on TRIATEK® Lighting’s website. For “LP Controller Users Guide” go to address:

<http://www.triateklighting.com>

Select “PRODUCTS” button, “Programmable Circuit Breaker Panel” hypertext link, and then select “User Guide” button.

10/10/04

Installing RCS-RM

The following pages of this installation guide will cover installation procedures for the RCS-RM. Unlike the RCS-FM, RCS-RM is shipped as separate components instead of one unit, and it is to be assembled in the field.

Figure 8
RCS1000 Enclosure

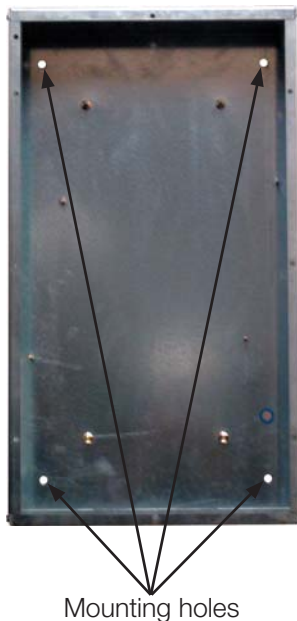

Installing the Breaker Panel Enclosure for the RCS-RM

1. Unpack the enclosure for the RCS-RM and check for any product damage. The enclosure will ship before the interior of the RCS-RM and the controller. Upon receiving the enclosure make sure there are no visible signs of damage, and that the correct size was shipped. Refer to the RCS1000 Data Sheet for ordering procedures.

2. Punch holes in the enclosure for line voltage and circuit wires. Refer to the Overview at the beginning of this user guide for different configurations of the RCS-RM related to line feed.

3. Punch holes in the breaker panel enclosure for circuit breaker control wire harnesses and controller power wires. Determine where the RCS-RM controller will be mounted in relation to the circuit breaker enclosure and punch holes in the corresponding side of the enclosure. The controller's hinged backplane and transformer prevent circuit breaker control wire runs out of the sides of the controller enclosure; therefore, holes should not be made on these sides of the controller enclosure. Holes for the controller power wires can be made on top, bottom, and side near the transformer assembly. See Figure 16 on page 21.

To make the holes, TRIATEK® Lighting's factory recommends using a combination of drilling pilot holes followed by knockout hole punching. If the customer will be mounting the RCS-RM directly to circuit breaker panel, the placement of the punch holes must match the placement of the holes to be punched in the RCS-RM. Make holes according to placement measurements in Appendix A of this manual.

4. Install the enclosure in the wall using anchors rated to hold 150-200 lbs. Four mounting holes are provided from the factory to mount the enclosure on the wall.



Note: When ordering an RCS-RM two breaker panel enclosures will be shipped. One breaker panel will be shipped first and a second will come with the interior installed in it. The first breaker panel enclosure is shipped ahead of time to allow for punching and mounting. The second is shipped only as a container for the interior. The interior is to be removed from this enclosure and mounted in the enclosure received in the first shipment. (The second adds no cost to the order. It can be kept as a backup or sent to the manufacturer. Contact TRIATEK® Lighting for further inquiry.)

Installing the Interior for the RCS-RM

1. Remove the dead front cover from the interior. Removing this cover is necessary to remove the interior from the enclosure it was shipped in. See note at the end of Step 4. The dead front is mounted to the interior by four screws.

Figure 9

Figure 10



Interior bus with dead front removed

2. Remove the interior. The interior is mounted to the enclosure by four bolts. Locate the bolts and remove the interior. See Figures 9 and 10. It is not necessary to remove the screw from the enclosure from which the interior is being removed. Just remove the nuts and remove the interior. After the interior is removed just replace the nut on the bolt it was removed from.

3. Mount the interior in the already installed enclosure. Keep in mind, the interior must be installed according to the line voltage feed. If the feed is into the bottom the main lugs or main breaker will positioned at the bottom of the interior. Top feed will have the main lug or breaker at the top of the interior. Use the nut and bolt provided in that enclosure. Remove the four nuts, install the interior and replace and tighten the nuts.

4. Remove the ground and neutral bars. The ground and neutral bars are mounted by two nuts. The bolts stay with the enclosure.

5. Mount the ground and neutral bars to the installed enclosure. Refer to the sticker on the inside of the breaker panel enclosure for ground and neutral bar positions. Top feed typically has the ground bar positioned on the left and the neutral bar positioned on the right, facing the opening of the enclosure. The interior ground and neutral bars should be installed with the interior in their correct positions when shipped. Remove the nuts in the same manner as for the interior, and install both bars just as they were shipped.

Do not reinstall the dead front cover until all circuit breakers have been wired. This includes wiring the circuit breakers to the controller interface board (discussed in the section "Wiring the RCS-RM").

Installing the RCS-RM

The RCS-RM contains an enclosure, the RCS-LMB controller, circuit breaker interface boards (CIB), the removable backplane, and transformer assembly. See Figures 11a and 11b.

Figure 11a

Removable backplane
 RCS-LMB Controller

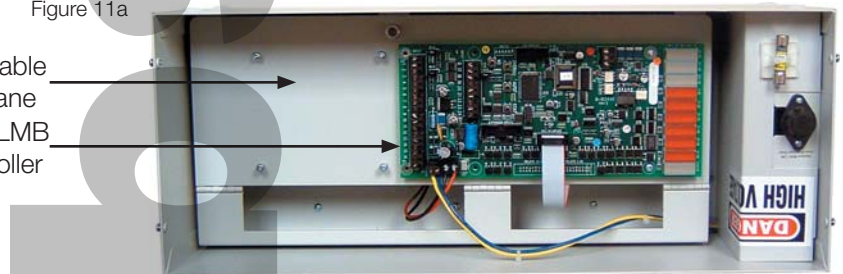

Figure 11b

CIB Boards
 Transformer and fuse assembly



The RM can be mounted up to and including 50 feet away from the circuit breaker panel, that is, *the length of the wires that connect the circuit breakers to the CIB boards, called circuit breaker control wires, cannot be longer than 50 feet.* If the RCS-RM is ordered, the RCS connector kit (RCSCK) and a crimping tool (RC SCT) must also be ordered to make circuit breaker control wire harnesses. Each control harness requires three stranded 20 AWG 600V insulation wires. TRIATEK® Lighting recommends using white, black and yellow colored wires for each harness.

1. Remove the circuit board backplane. The backplane is a hinged bracket that holds the CIB boards and the LMB controller. It is mounted by six screws to the RCS-RM enclosure. The backplane must be removed for drilling and/or knockout punching, and to access the four mounting holes in the enclosure. See Figure 12. Before removing the backplane the power connector must be removed from the LMB. (The RCS-RM is shipped with the transformer power harness connected at the LMB.) The power harness consists of a yellow and a blue wire terminated in a black connector block. See Figure 13.

Figure 12

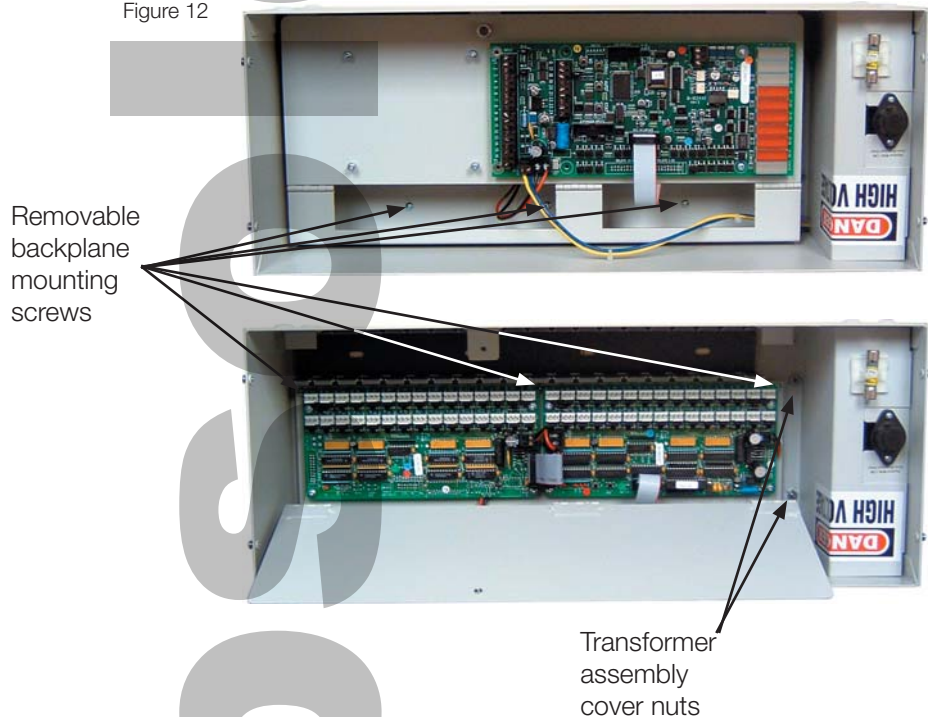
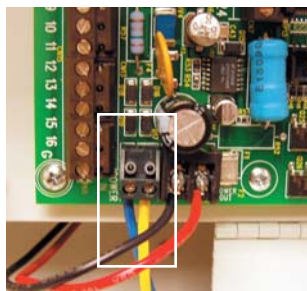

Figure 13



Power connection (blue/yellow harness)

(a) Remove the power harness on board. This is accomplished by grasping the harness at the connector block and pulling upwards away from the plane of the board. See Figure 13 in the margin.

(b) Remove the six screws that hold the backplane.

(c) Remove the backplane.

2. Remove the controller transformer and fuse. See Figure 14. Once the backplane is removed the transformer and fuse must also be removed. The transformer is covered by a high voltage plate that is fastened by two nuts. These nuts are most easily removed with a driver set.

(a) Remove the spade connector at the fuse. A voltage (277 or 120VAC) wire from the transformer is terminated at the fuse by a spade connector. The wire's tag indicates the voltage of the wire. When reinserting the spade connector be sure it is the correct wire by referring to the tag.

(b) Remove the transformer. The transformer is mounted by two similar nuts as with the cover. Remove the nuts and pull the transformer out.

(c) Remove the fuse housing. The transformer fuse is seated within a housing mounted to welded bracket on the RM enclosure. The fuse itself does not need to be removed from the housing; remove the entire housing. The housing is attached to its welded bracket by two small philips head screws. Remove the screws and then remove the fuse housing.

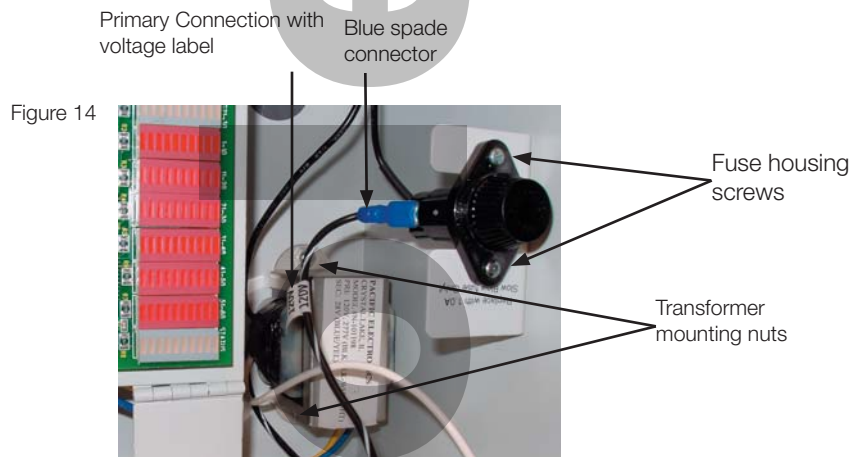

3. Knock out holes in the RCS-RM enclosure. Holes need to be made that allow Circuit breaker control wires (white/black/yellow harnesses) to be run into the circuit breaker panel. If the controller will be mounted directly to a side of a breaker panel (see "Wiring Applications" in the Overview of this manual) holes should be made according to placement measurements given in the diagram in Appendix A, and they should match those made in the breaker panel enclosure. For hole sizes refer to details of step 4. Holes for extra circuit breaker control wire runs to additional panels can be made through the bottom of the controller enclosure, and not the sides. The movement of the hinged backplane and the transformer housing prevent circuit breaker control wire runs out of these sides. See Figures 15 and 16.



Holes for power supply wires to be run to the controller enclosure can be made in either the top, bottom or right side (transformer side) of the enclosure. Figure 16 shows possible hole placements for circuit breaker control wires and incoming power supply wires.

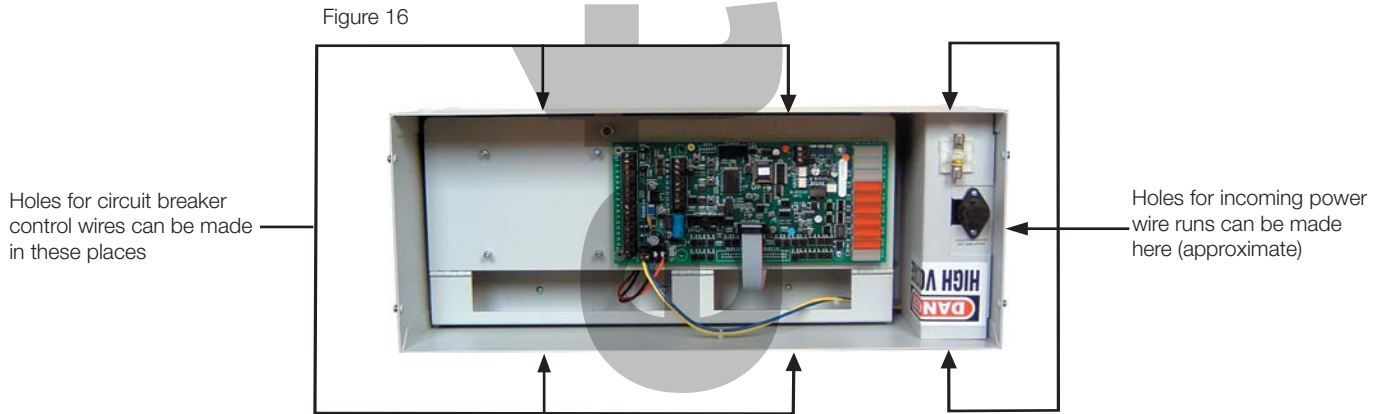

4. Connect the breaker panel enclosure and RM enclosure. Read “Controller to Breaker Panel Mounting Configurations” and “Wiring Applications” in the Overview at the beginning of this manual before performing this step.

The RCS-RM controller can be connected directly or remotely to breaker panels.

For remote mounting use conventional electrical conduit to connect the controller to the breaker panel. Be sure holes are placed according to details of Figure 16. Install the conduit according to convention.

For direct mounting, instructions are given below as a suggested means using TRI-ATEK® Lighting factory specified hardware. Hardware components are displayed in Figure 17.

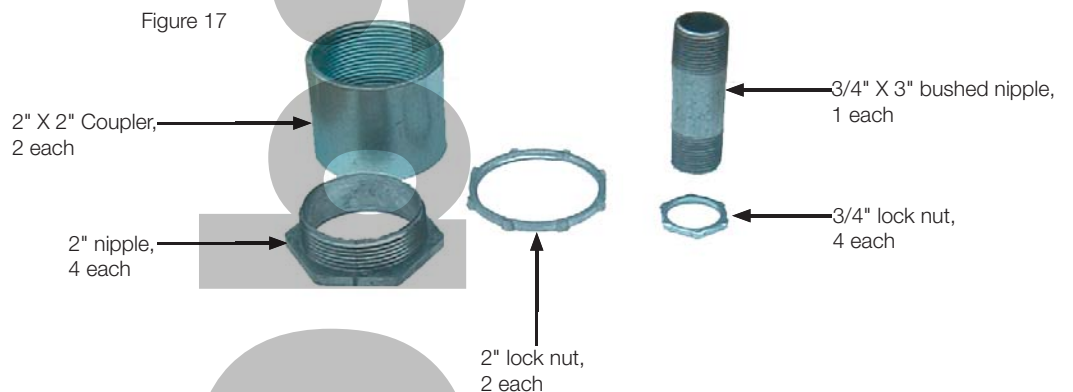

(a) Install the hardware. To install the hardware refer to illustrations in Figures 18a and 18b below. The illustrations give two angled views of the connections to demonstrate how the hardware components are installed.

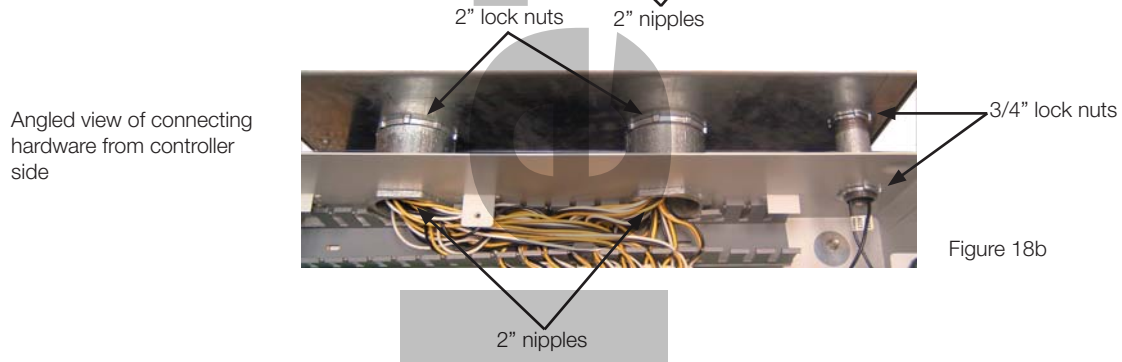
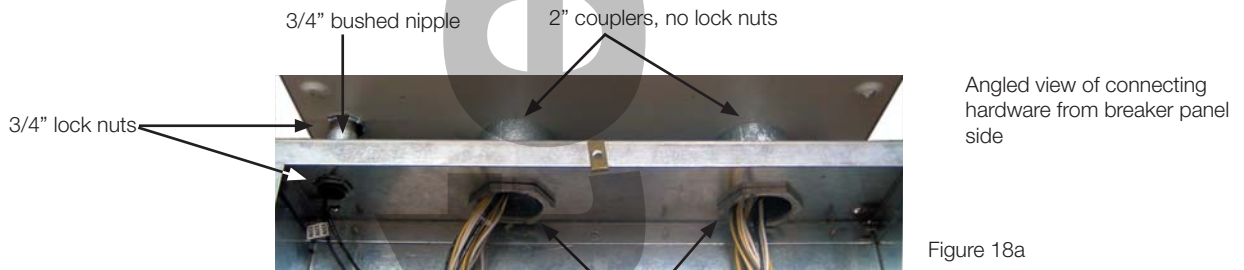

Notice from the illustration above that there are 3 total wire channels made: Two 2" channels and one 3/4" channel. Each 2" channel uses one 2" coupler, one 2" lock nut, and two 2" nipples. The 3/4" channel uses one 3/4" X 3" bushed nipple, and four 3/4" locknuts.

5. Anchor the RCS-RM to the wall.

Once the RCS-RM is connected to the circuit breaker panel, use anchors for mounting that are rated to hold 25-50 lbs. Ensure the bolt fits in the hole provided; otherwise, larger holes must be drilled. Install the anchors, place the RM enclosure on the wall aligned with the holes, and bolt on.

Mounting the RCSFK brackets and screws

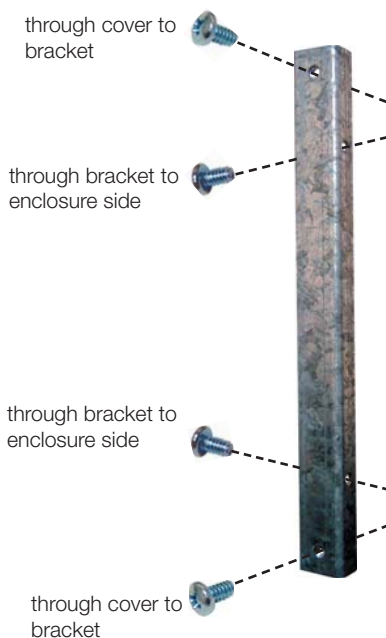

Figure 19

6. If flush mounting the RCS-RM, install RCSFK.

The RCSFK simply includes a flush mount door for the RCS-RM and two brackets with screws to mount it. Use Figure 19 in the margin as a guide to install the RCSFK.

7. Reinstall fuse housing, transformer, high voltage cover, and backplane in reverse order of removal. Refer to instructions 1 and 2 with sub-steps. Refer to Appendix B for instruction on how to ensure proper voltage wire is connected.

Wiring the RCS-RM

Refer to "Wiring Applications" in the overview of this manual in conjunction with this section. Wiring the RCS-RM to the circuit breakers involves obtaining and making circuit breaker control harnesses. These wires are not provided by TRIATEK® Lighting. Each harness requires three stranded 20 AWG 600V (TRIA TEK Lighting recommends Belden #32720 or equivalent.) insulation wires. TRIATEK® Lighting recommends using white, black, and yellow colors for each harness. The RCSCK and RCSCT can be used to make the control harnesses. RCSCK is the connector kit that comes with 120 connectors. The RCSCT is the crimping tool needed to crimp the connectors onto the wire ends. Figure 20 below displays a crimping tool, a 3 pin connector, and an example wiring harness.

Figure 20



RCS Crimping tool components (RCST)



Example 10' wiring harness terminated at one end

 One connector with strain relief.
 The RCSCS is 120 of these

For connecting wires to circuit breaker panels that are mounted directly to the controller, harnesses can be made and installed in the following order: (1) Measure and cut the wires, (2) Crimp connector to one end of the harness wires and connect that end of harness to the CIB board. (3) Pull the wires into the breaker panel. (4) Crimp the connector to other end of the harness and terminate it onto the correct circuit breaker. (5) Repeat 1-4 for all circuit breakers. **This sequence is used and explained with illustrations below.**

For connecting wires when the controller is mounted at a distance that requires equipment to pull, the following order is recommended: (1) Label each harness with electrical tape and write its number in permanent ink on the tape. Do not wrap the tape in such a way that the tape could easily snag, (2) Pull necessary length of wire into the breaker panel. (3) Crimp on connectors to terminate CIB connecting ends, and then (4) Crimp connectors and connect to breakers at the other end. (5) Repeat 1-4 for all circuit breakers. Use individual step details given below for reference.

1. Measure and cut the wires. Circuit breaker control wires should not be too tight between the CIB boards and the circuit breakers. Estimate a generous length of wire and cut. Any excess wire can be cut later.

2. Crimp the wires at CIB end. Each harness needs three wires. Recommended color usage is: White=common, Black=signal, Yellow=Feedback.

(a) Assemble the RCST Crimping Tool. The RCST is shipped in three pieces. See Figure 20. Follow its instructions to assemble the crimper.

(b) Load the connector in the direction of the arrow at the top of the crimper. The connector should fit as shown in Figures 21a and 21b.

Figure 21a Top view connector loaded

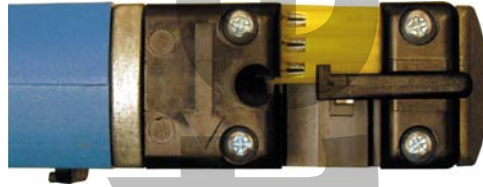
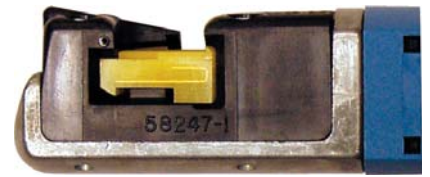

Figure 21b Side view connector loaded



(c) Crimp the wire in order of (1) white, (2) black, (3) yellow. Insert the wire into the loading slot, all the way down. Make sure the teeth into which the wire will be crimped are aligned with the wire. Pull the trigger and the wire will be forced between the holding teeth. See Figures 22a and 22b for illustrations.

Figure 23



Proper wire order after crimping

Figure 22a Crimping the white wire

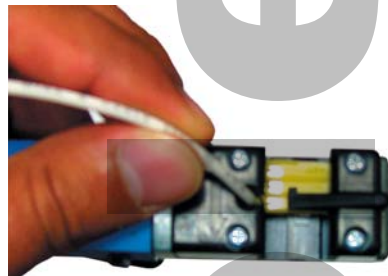
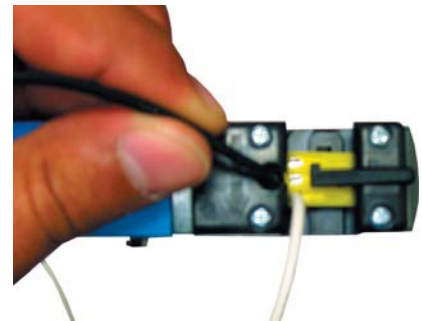

Figure 22b Crimping the black wire



After crimping the yellow wire, remove the connector and look at the back. The wires should be in the order as shown in Figure 23 in the margin. Snap the strain relief cap onto the connector and label it by breaker number.

Figure 24

Wire harnesses to connect to odd numbered circuit breakers (left side facing)



Wire harnesses to connect to even numbered circuit breakers (right side facing)

CIB #2: Breakers 31-60

CIB #1: Breakers 1-30

Labeled harnesses on connector strain reliefs

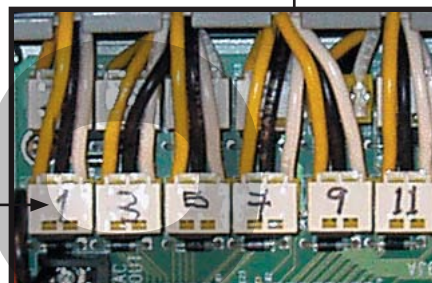
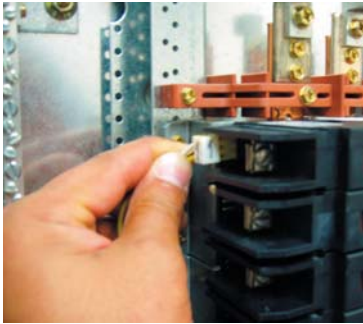

Figure 25



Connecting a harness to a breaker.

3. Connect and label the connectors at the CIB boards. Open the front plate of the backplane to examine the CIB boards. Notice that along the top edge of each board are terminating pins numbered 1 through 30 on each board. The board to the right is CIB #1 and circuit breakers 1 - 30 should be wired there. The board to the left is CIB #2 and circuit breakers 31- 60 are terminated there even though termination pins are numbered 1 - 30. At this point take note of numbering for measurement purposes.

4. Pull the harness into circuit breaker panel. Odd numbered breakers, top-down increasing, are mounted on the left side facing the panel. Even numbered breakers are on the right. Wires should not be pulled and connected too tightly. Leave enough slack (including 1/4" length for crimping) so that the wires can terminate loosely. Pull the harness through the proper side. See Figure 26.

5. Crimp the wires at the circuit breaker end. Repeat the procedures in Step 2.

6. Terminate the harness at the circuit breaker. See Figure 25 for termination header at the circuit breaker. All breakers on the left side of the panel should be routed through the corresponding opening through to the RM, right side similarly. Notice a plastic wire tray is provided with slots to separate pairs of harness.

7. Repeat Steps 1-6 for all circuit breakers. When all wires have been terminated harnesses can be tied down to remove clutter and to organize the wires.

8. Connect the low voltage power from the transformer (via slow blow fuse).

This can be accomplished by supplying power through a circuit breaker. Power can also be connected to an existing breaker in the panel that is non-controllable. *Note: An extra standard (non-controllable) circuit breaker must be ordered. If power wires are connected to a controllable circuit breaker and that breaker is accidentally controlled to OFF, the controller will then lose power and all remote control of the RCS1000 will be lost.* To connect controller power to a circuit breaker, obtain two pieces of 18AWG 600V insulated wire. One will be the neutral wire and the other, the hot wire. Strip both ends of both pieces as needed. Connect the neutral wire to the neutral bar. Next, connect the voltage wire (either 120V or 277V) to the branch circuit connector by unscrewing the connector plate, inserting the wire between the plate and the connector base, and retightening the screw.



Steps 8-9



CAUTION: Controller ships with dual coil transformer fused to 120 volt lead. To supply transformer with 277V, connect 277 transformer lead to the fuse holder and connect fuse holder lead to the branch circuit breaker. See page 33 for fusing detail.

9. Switch line power to the breaker panel. If the breaker panel is Main Lug Only (MLO), the controller board should now have power. The system status LED in the upper right hand corner of the board should be flashing. (See LP Controller Users Guide for operational details of the controller board.)

10. Reinstall deadfront cover and all trim.

Upgrading the RCS1000

There are three basic upgrades provided for the RCS1000 Series Panels. They include: circuit breaker upgrade, switch input expansion board, and Digital Device Network Link (DDN-L). See RCS1000, and LP-PRO data sheets.

Installing Additional Breakers

As mentioned in the data sheet, TRIATEK Lighting offers two main types of circuit breakers, each with various pole and amp ratings. All breakers are installed using the same method.



WARNING! Before installing additional breakers switch off main line power to the circuit breaker panel.

1. Remove dead front cover. If the dead front cover is currently installed unbolt the four mounting bolts, and pull the dead front from the interior. The face of the dead front cover contains the numbering order for the breakers. Numbers increase firstly horizontally towards the right and then vertically down. Odd numbers are on the left, evens are on the right. This number information is important for connecting the circuit breaker to the interface board.

Figure 26

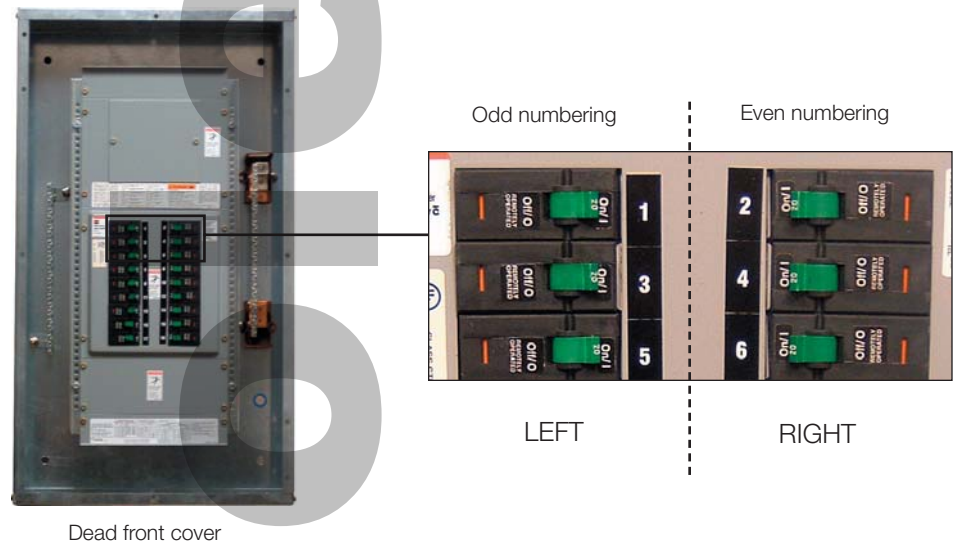

2. Seat and bolt the circuit breaker. See Figure 27. Once the position of the new breaker is identified, the breaker can then be seated in place. The interior bus contains two points to hold the breaker in place. A small tab extension on the outside of the bus fits into a slot underneath the low voltage connecting header of the breaker. The second point is for the bolt-on tab of the breaker. Place the breaker at an angle to slide the small bus extension tab into the slot of the breaker. Then lower the bolt and tab over the bolt opening on the bus and then bolt the breaker down. It is easy for the breaker to come unseated at the slot and extension tab. Ensure it is secure after bolting.

Figure 27 Before adding a new circuit breaker

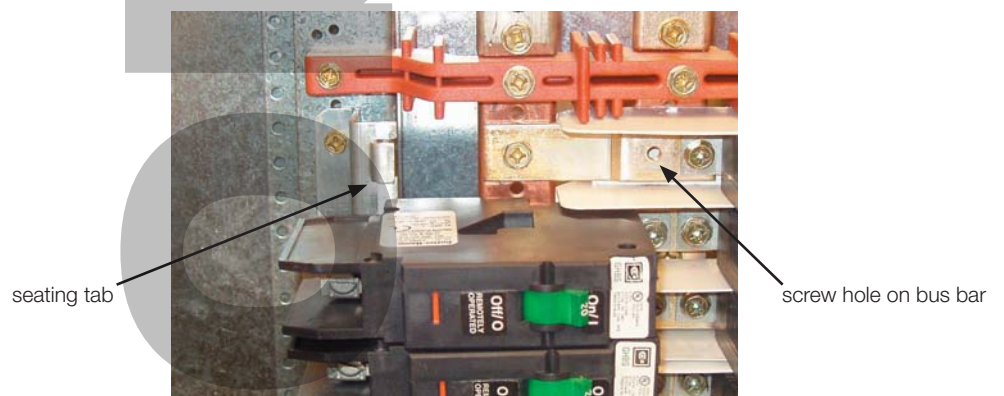

3. Connect wiring harness from circuit breaker to the interface board. Consult “Wiring the RCS-RM” of this installation guide for instructions.

Installing the Switch Expansion Board

The switch expansion board gives the RCS1000 Controller the capability to manage 32 additional hard-wired switch inputs. The controller can handle up to 120 total switch inputs for which a total of 3 expansion boards are needed. Only one expansion board can be mounted in the RCS1000 unit. Any additional expansion cards must be mounted remotely. Contact TRIATEK® Lighting for mounting options.

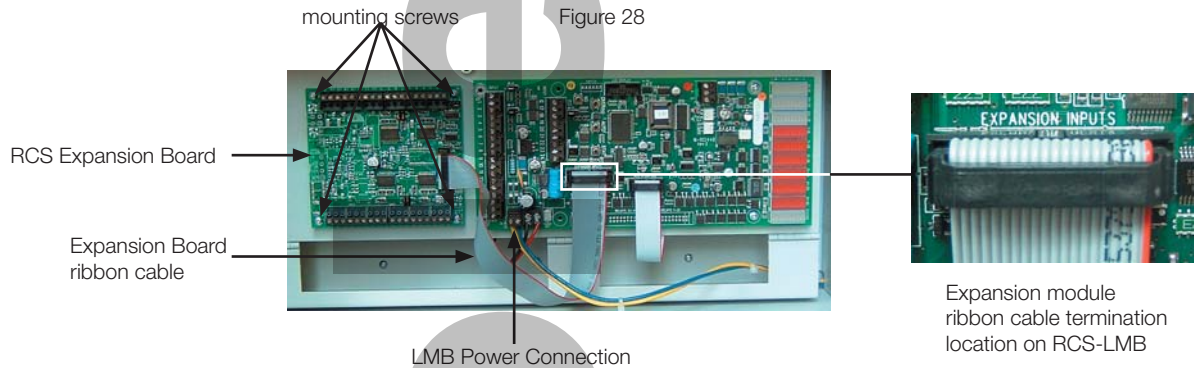

CAUTION: Before handling any components on the circuit board, the installer should be grounded.

- 1. Remove power from the controller.** This is to prevent damage to electrical components of the controller while connecting ribbon cable.
- 2. Mount the expansion board.** The expansion board is mounted to the left of the RCS-LMB controller. Four screws are provided. See Figure 28.
- 3. Connect the ribbon cable as shown.** The ribbon cable connector is keyed to ensure it is connected properly. The male connectors on both the expansion board and controller provide a slot for the key notch on the cable connectors. See Figure 28 for ribbon cable connection location on the RCS controller board. The board does not need a separate power source. It receives power through the ribbon cable.
- 4. Reconnect power to the controller.**

Installing the DDN-L Module

The DDN-L module is mounted via standoffs directly to the RCS controller. See Figure 29 for components shipped with the DDN-L module.

Figure 29

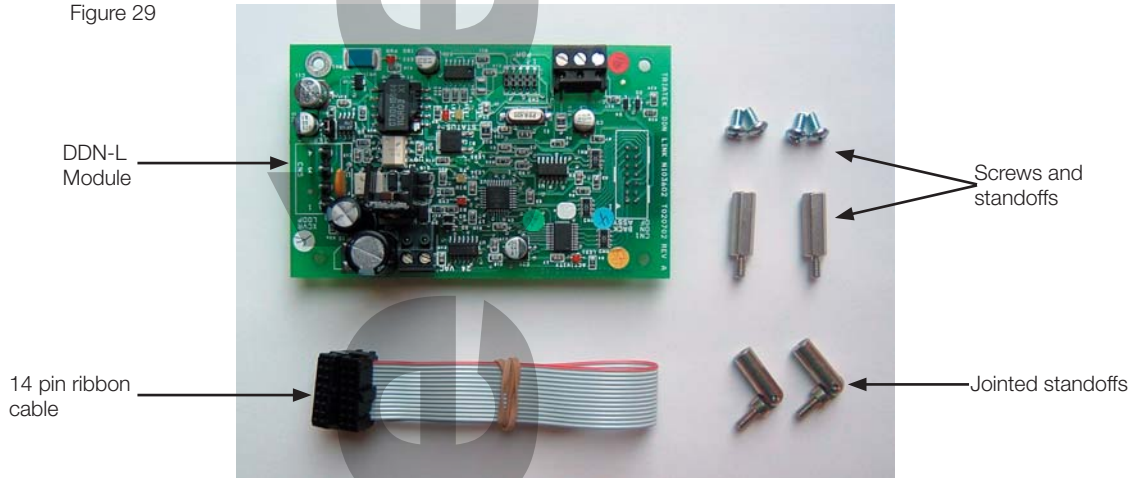

CAUTION: Before handling any components on the circuit board, the installer should be grounded.

- 1. Remove power to the controller.** This is to ensure none of the circuitry is damaged during installation.
- 2. Install the standoffs.** The DDN-L module mounts directly above the switch inputs on the RCS controller board. Locate the four mounting holes, two of which will contain screws that hold the RCS controller to the backplane. See Figure 30.

Figure 30

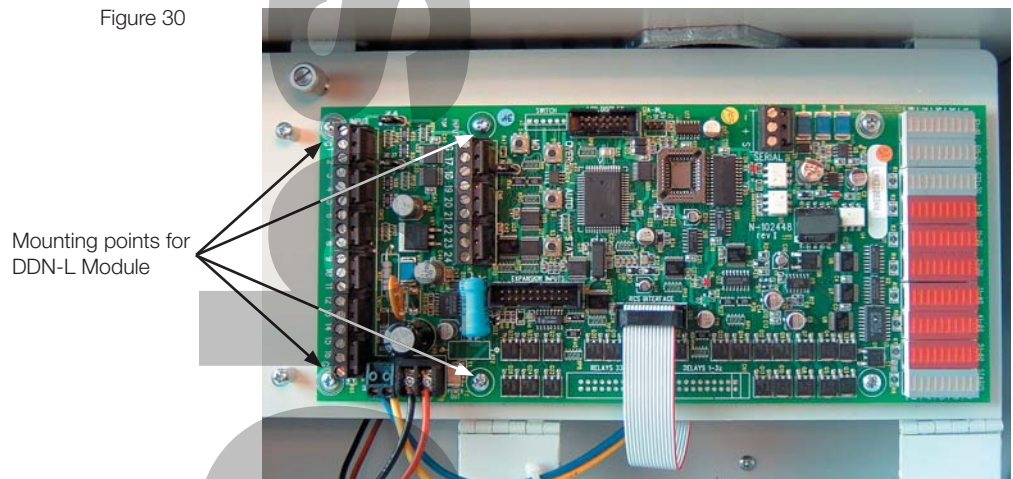

Install the two standard standoffs in the top two holes, and the two jointed standoffs at the bottom two holes. The jointed standoffs give the capability to open and close the DDN-L module as if on a hinge. The jointed standoffs should be installed so that the upper half of each standoff rotates at the joint in a vertical fashion.

Figure 31

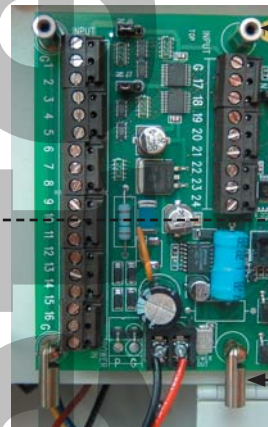

Straight, non-jointed standoffs installed at top two points

Install jointed standoffs so that the joint allows vertical movement

3. Connect power at controller end. The DDN-L receives its power from the RCS-LMB controller. Obtain approximately six inches of stranded 18AWG 600V insulated 2-conductor. Remove the power termination block that shipped with the DDN-L module. Strip and terminate one end of the wire to the DDN-L power terminal block, and strip and terminate the other end of the wire to the non-removable terminal block on the controller. The second terminal block has two wires that supply power to the CIB boards. **See Figure 32 on the next page.**

Figure 32

Power cable connections for the DDN-L Module

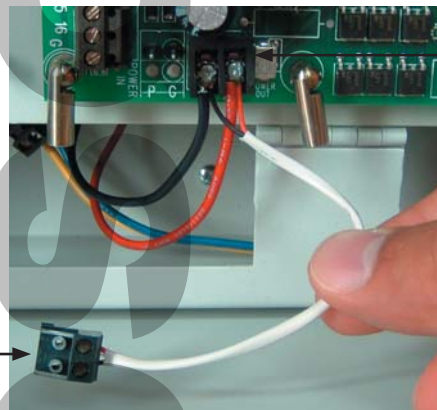

Non-removable power termination block on RCS-LMB

Power termination block from DDN-L Module

4. Mount the DDN-L to the standoffs.

(a) Fasten the module to the two non-jointed standoffs first. Place and align the module over the two holes and fasten the screws. Do not screw too tightly at this step because once the module is fastened to all four screws the top two will need to be removed to install the ribbon cable.

(b) Fasten the board to jointed standoffs. Fasten one at a time. Align the movable portion of the jointed standoff with its hole. Then insert and fasten the screw while ensuring that the standoffs do not twist. If the standoffs twist while screwing the DDN-L module, the module will not open for installation of the ribbon cable. See figures 33a and 33b for open and close movement of the DDN-L module for installation of the ribbon cable.

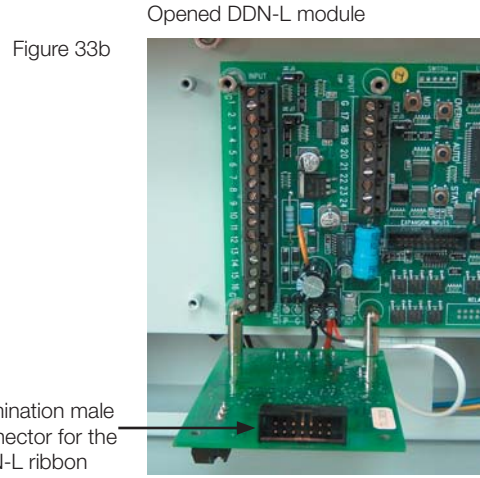
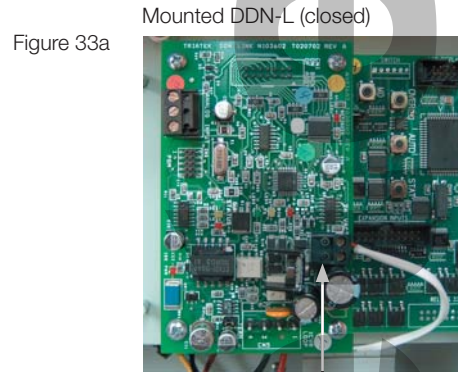

Power Installed

Termination male connector for the DDN-L ribbon cable

5. Connect the ribbon cable as shown. Plug one end of the ribbon cable onto the termination connector on the DDN-L. See Figures 33 and 34. Plug the other end into the termination connector labeled “LCD Display” on the RCS-LMB controller. “LCD Display refers to an application not used with the RCS1000. Both connectors on the ribbon cable are keyed to fit slots on the respective male connectors.

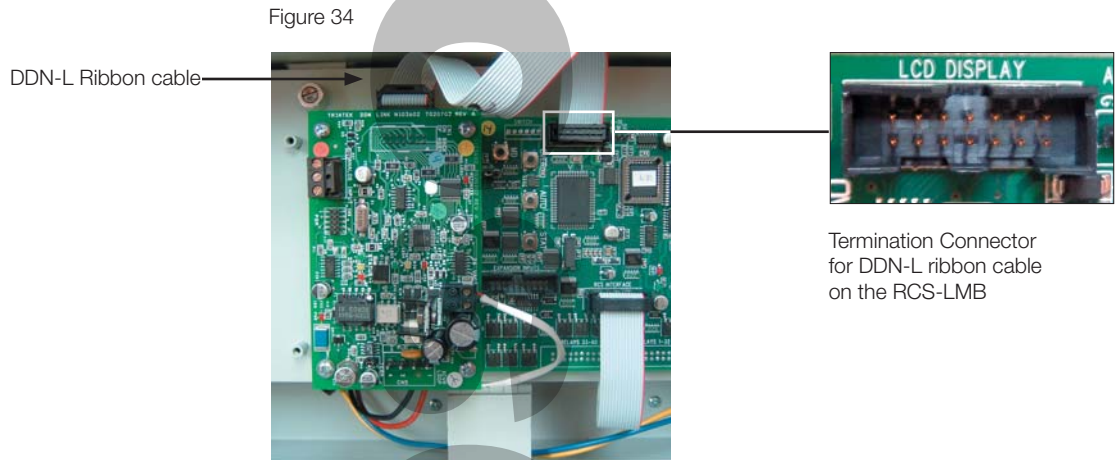

6. Connect the power at the DDN-L. Plug the terminator block of the power cable to the same position it was shipped.

7. Reconnect power to the RCS-LMB.

Note: For information on operating components of and programming the RCS-LMB controller, refer to the “LP Controller Users Guide” available on TRIATEK Lighting’s website. For “LP Controller Users Guide” go to address:

<http://www.triateklighting.com>

Select “PRODUCTS” button, “Programmable Circuit Breaker Panel” hypertext link, and then select “User Guide” button.

Connecting TRIATEK Lighting LS5 Photocell Inputs

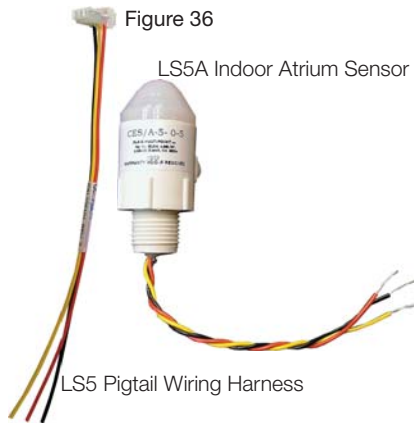

The RCS1000 Controller comes with one input for the LS5 Series Photocells. Each LS5 photocell ships with one pigtail wiring harness. The contents as shipped are shown in Figure 36. The LS5 photocells have three (3) wires each. Figure 35 gives a wiring schematic for an example LS5 photocell.

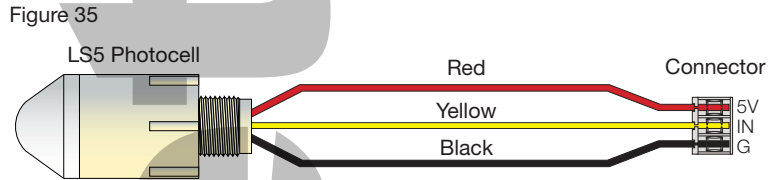

The photocell is powered by 5V from the RCS1000 Controller. The power circuit includes the Red (5V hot) and the Black (ground) wires. The yellow wire carries the 0-5V input signal from the photocell which is then scaled to a value used by the LPPK Software. Instructions for installing the LS5 Photocell follow.

Figure 37 Location of LS5 Photocell Input Socket on the LMB

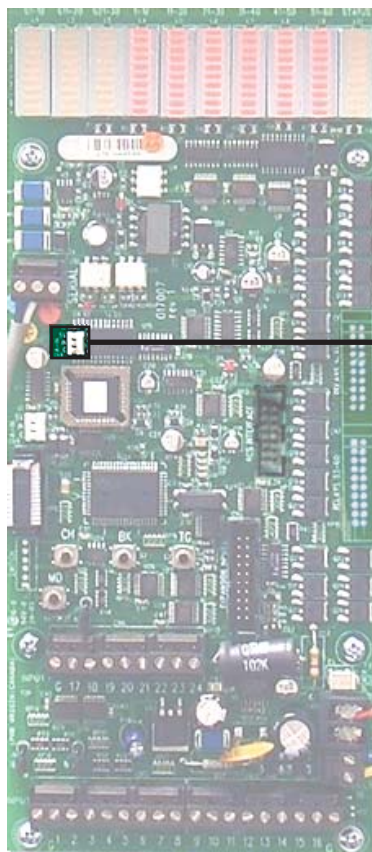

1. After installing TRIATEK Lighting's LS5 Photocell, splice extension wires to photocell wires. If possible use the same color wires provided with the photocell. A maximum of 500 feet of wire total is allowed, measured from the photocell to the LMB socket. Use 18-22AWG wire.

2. Remove power from LMB.

3. Locate the photocell input socket on the LMB. See Figure 37 for its location and labeling.



4. Splice wires to the pigtail provided with the photocell. Pigtail wire colors match those provided with the photocell. Splice wires to match the color coding.

5. Plug the connector onto the socket on the LMB. The pigtail connector is keyed to fit in one orientation on the LMB socket. Figures 38 shows the proper orientation to install the connector.

Figure 38

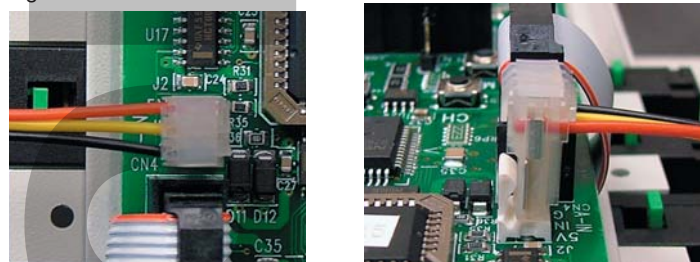

6. Reconnect power to the LMB.

Appendix A: Measurements for Placement of Connection Holes

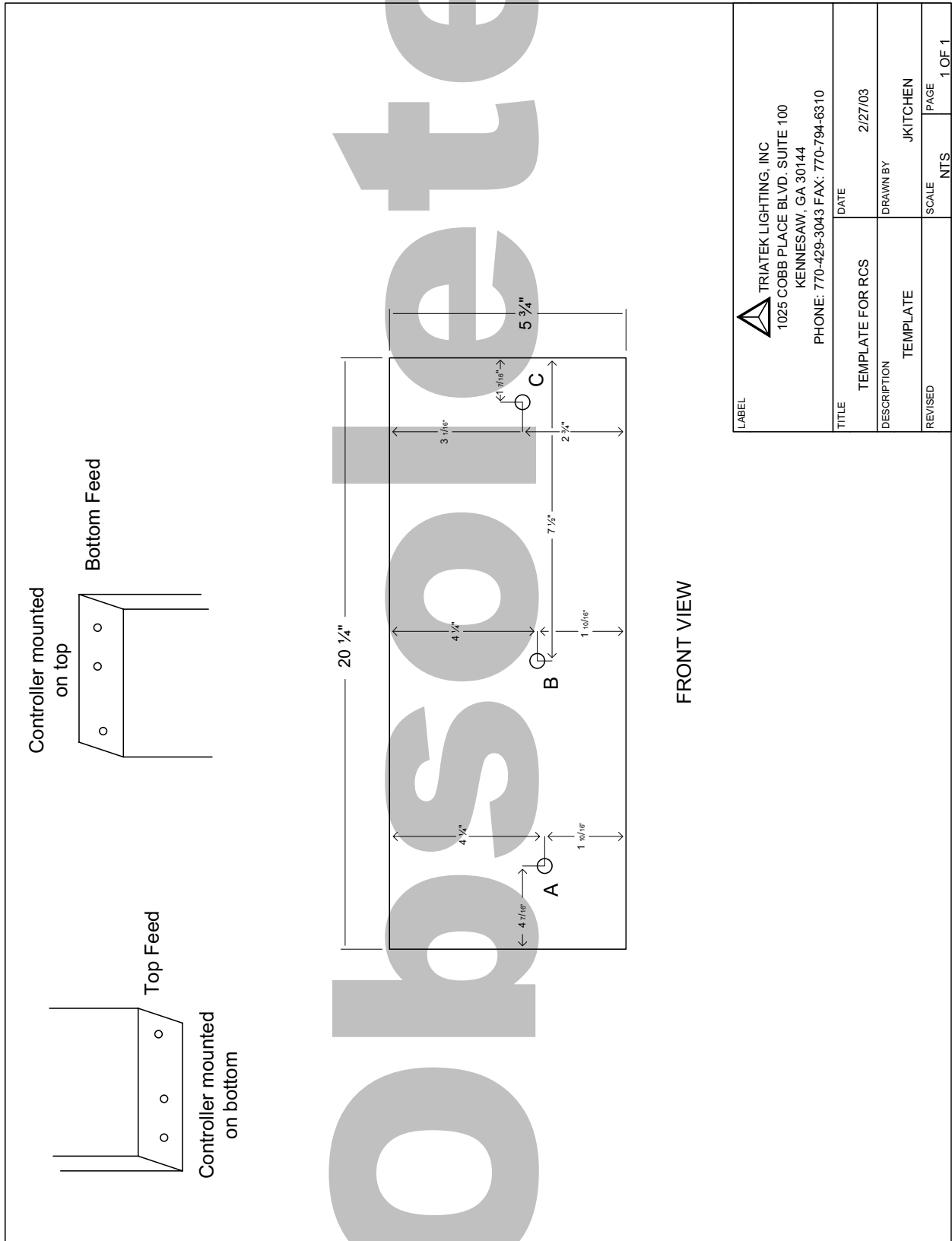

 <p>TRIATEK LIGHTING, INC 1025 COBB PLACE BLVD. SUITE 100 KENNESAW, GA 30144 PHONE: 770-429-3043 FAX: 770-794-6310</p>	DATE	2/27/03	PAGE	1 OF 1
	TITLE	TEMPLATE FOR RCS	SCALE	NTS
	DESCRIPTION	DRAWN BY	JKITCHEN	
	REVISION	SCALE	NTS	

Appendix B: Power Supply Quick Connect of Transformer to Fuse

Transformer Connections 2

RCS Models after year 2002

