

Hardware Installation and Setup Instructions



Table of Contents







Overview	
Document	3
Component	3
Assembly	3
Voltage Separation	3
Preparation	
Junction Box	4
Zone Control (ZC)	4
Mounting	5
Terminations	
Line Voltage	5
Low Voltage	6
Reassembly	9
Controller Board (CB) Setup	10
0-10VDC Ballast Test Procedure	11

Visit www.BRTint.com/tandc.html for Terms and Conditions of Sale

Attention

This section serves as a notice of the immediate or potential dangers involved when working with the equipment described throughout this manual. Any person involved in installation, maintenance, or service of the equipment should first carefully examine the equipment and read the instructions contained in this manual to ensure that personal and/or equipment injury is avoided.

The following safety messages appear throughout this manual to alert of immediate or potential danger to life as well as property.

	NOTE : Indicates an important note.
	TIP : Indicates a helpful tip or trick.
	SAFETY REMINDER : Applicable safety instructions will be included with this symbol.
	DANGER : Indicates an immediately hazardous situation which, if not avoided, will result in serious injury or death.
	WARNING : Indicates a potentially hazardous situation which, if not avoided, may result in serious injury or death.
	CAUTION : Indicates a potentially hazardous situation which, if not avoided, may result in minor or moderate injury.

Disclaimer

This equipment has been tested and found to comply with the limits for a Class A digital device, pursuant to part 15 of the FCC Rules. These limits are designated to provide reasonable protection against harmful interference when the equipment is operated in a commercial environment. This equipment generates, uses, and can radiate radio frequency energy and, if not installed and used in accordance with the instruction manual, may cause harmful interference to radio communications. Operation of this equipment in a residential area is likely to cause harmful interference, in which case the user will be required to correct the interference at his own expense.

Instructions contained in this user's guide should be performed only by qualified persons in accordance with local and national codes. Blue Ridge Technologies International, LLC and its affiliates assume no responsibility for any consequences related to the improper use of this manual.

Overview : Document

This document provides mounting and connection instructions for the following Blue Ridge Technologies Zone Control (ZC) products :

- BRZCSS-00-00
- BRZCSS-00-BT
- BRZCDS-00-00
- BRZCDS-00-BT

These ZC models are compatible with 4" and 4 11/16" junction boxes.

ZC enclosures are Type 1 rated and must be mounted in a dry / indoor environment.

Sections of this Install Guide apply to optional equipment and may not be applicable.

For ZC integration with a Building Automation System (BAS) as well as software configuration refer to the Application Guide.

Overview : Component

The ZC includes the following items :

- 1 – ZC
- Blue Tooth Module (Optional)
- BT485 BAS Network Terminator (BT485 Terminator) (Optional)

Overview : Assembly

1. Line Voltage (FI-1 Board)
2. Low Voltage (FI-2 Board)
3. Controller Board (CB)
4. Cover Assembly
5. Exclusion Frame
6. Lower Mounting Frame (LMF)

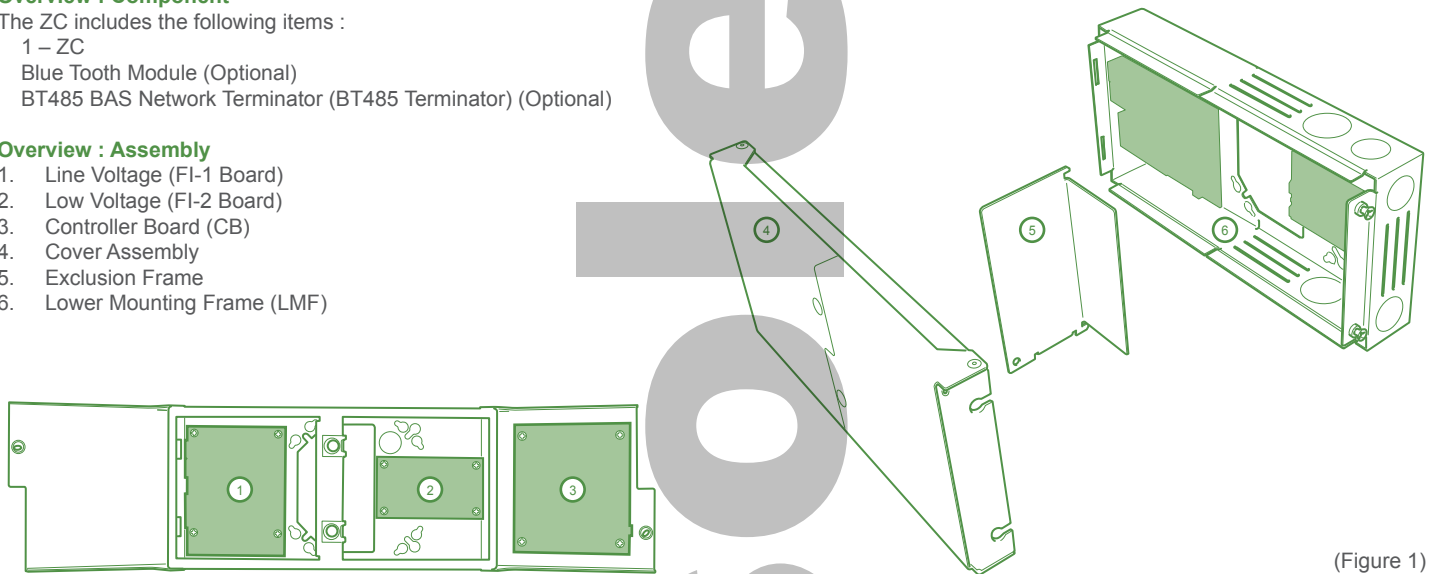

(Figure 1)

Overview: Voltage Separation

- Line Voltage: The ZC line voltage compartment includes the interior left of the Exclusion Frame and the junction box. Utilize the line voltage chase to route line voltage leads between these two areas. (Figure 2)
- Low Voltage: The ZC low voltage compartment includes the area right of the Exclusion Frame. Utilize the low voltage knockouts to bring low voltage leads into this compartment. (Figure 2)
- Class 1 Analog Outputs: In some installations the analog output leads may be run as Class 1 circuits and enter the junction box via a line voltage conduit. Utilize the Class 1 analog output knockout to bring these leads into the low voltage compartment. Early ZC models do not include a Class 1 Analog Output knockout and will require drilling a 7/8" hole for a 1/2" bushing. (Figure 3)

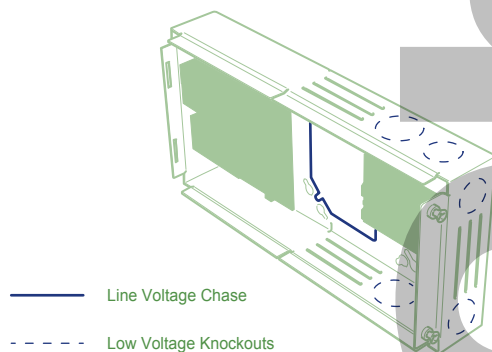

(Figure 2)

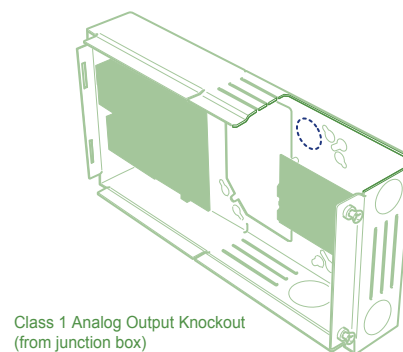

(Figure 3)



Disconnect line voltage power before performing ZC installation.



Before handling any ZC components, the technician should be grounded to prevent circuit board damage.

Preparation : Junction Box

Junction box preparation prior to mounting will aid ZC installation. Consider the following requirements during preparation:

- The push to connect terminal block on the FI-1 Board will accept a single 14-10AWG solid or stranded copper wire per terminal. Consolidation of multiple line voltage wires into a single lead may be necessary. (Figure 6 and 7)
- All line voltage leads must be dressed to the left. This will aid termination and ensure clearance of the ZC Exclusion Frame.
- All circuits must be tested for wiring errors and shorts prior to ZC installation.

Preparation : ZC

Preparing the ZC prior to installation will ease mounting and wire termination. (Figure 4)

1. Confirm power is disconnected from the ZC.
2. Disconnect ribbon cables from the CB.¹
3. Loosen the fasteners on the right side of the ZC to remove the Cover Assembly from the LMF.
4. Remove the Exclusion Frame from the LMF.
5. Remove mounting fastener knockouts from LMF. Only remove fastener knockouts which correspond with junction box to be used. (Figure 5)
6. Carefully remove applicable low voltage knockouts from LMF.² (Figure 2) See page 6 for low voltage instructions.
7. Remove Class 1 Analog Output knockout from LMF if applicable. (Figure 3)

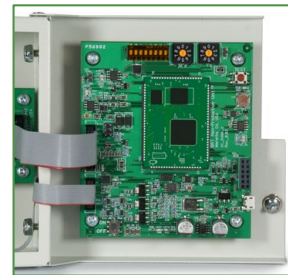
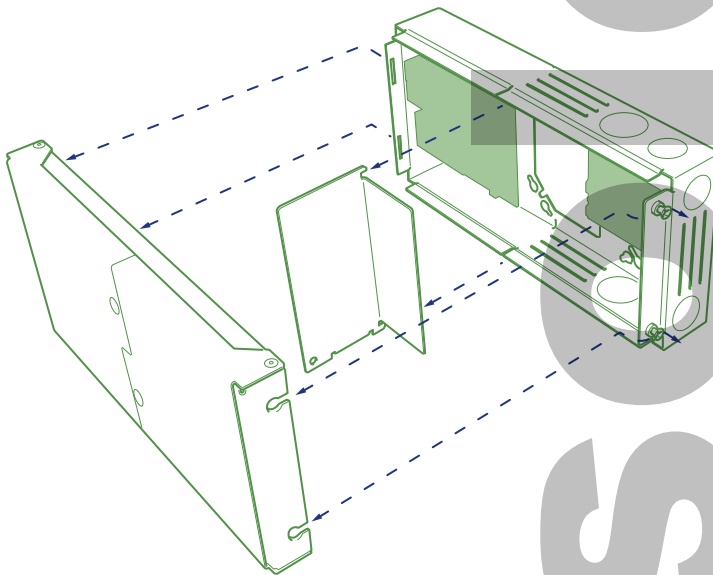

(Figure 4)



¹ Disconnect power to the ZC before installing or removing ribbon cables. Failure to do so could result in damage to the electronics.

² Proceed with caution while removing low voltage knockouts. Do not damage the FI-2 Board.

Mounting

Mount ZC to the junction box.

1. Confirm power is disconnected from the junction box.
2. Guide line voltage leads through the line voltage chase.
3. Position the fastener knockouts in the LMF on the corresponding junction box cover fasteners. (Figure 5)
4. Tighten junction box cover fasteners.
5. Prepare ZC with low voltage conduit / bushings and wire necessary for the application.

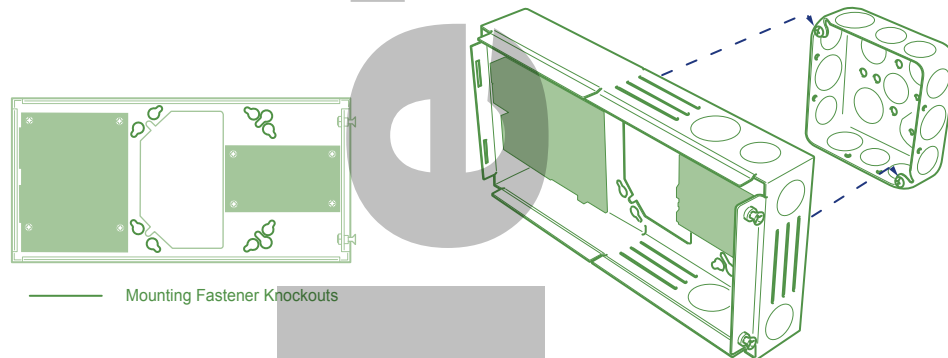

(Figure 5)

Terminations : Line Voltage

All line voltage leads are terminated in the push to connect terminal block on the FI-1 Board. (Figure 6) Terminal labels are located on the FI-1 Board and inside of the Cover Assembly for field reference. Wires must be routed to enter the LMF as far left as possible to ensure clearance while reinstalling the Exclusion Frame.

1. Confirm power is disconnected from the junction box.
2. Route the wire.
3. Cut to length and strip as appropriate.
4. Insert stripped wire into terminal. (Figure 6 and 7)
5. Repeat for each lead.

Line Voltage Specifications

Power Feed: 120, 230, or 277VAC, 50/60hz, +/- 10%, single phase, 20A circuit (powers ZC and feeds relay outputs)

ZC Maximum Load Rating: 20A

Relay Maximum Load Rating: 20A tungsten @ 120VAC, 20A ballast @ 277VAC, 20A resistive @ 277VAC, 2hp @ 120VAC

Relay: 2 mechanically latching relays with manual override lever

Relay Status: Opto-isolated Power Tap (PT) on load side of relay contacts

Line Voltage Input: 2 switch inputs, must utilize same ZC power feed

Line Voltage Input Type: Configurable for maintained or state-change

Wire Requirement: 14-10AWG (Solid or Stranded copper wire only)

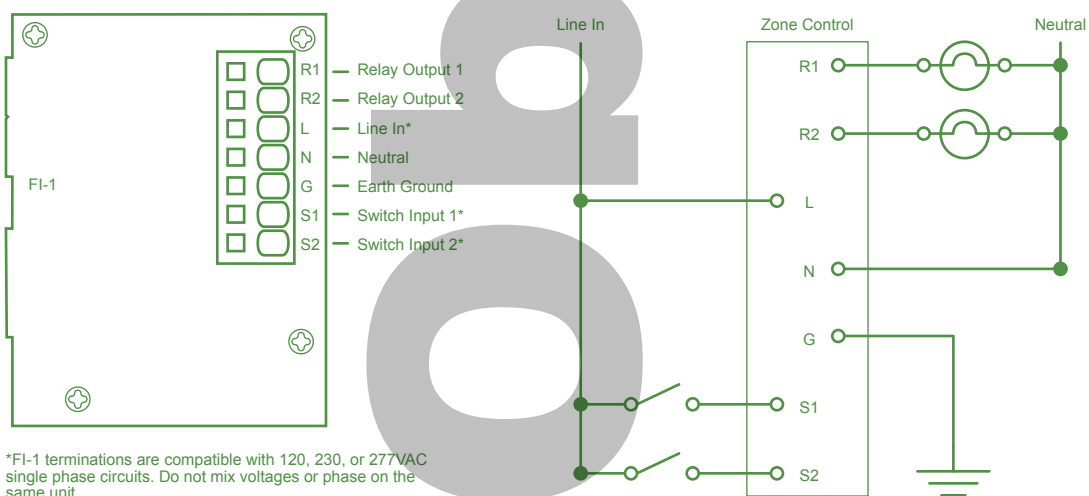

*FI-1 terminations are compatible with 120, 230, or 277VAC single phase circuits. Do not mix voltages or phase on the same unit.

(Figure 6)

(Figure 7)

Terminations : Low Voltage

All low voltage leads are terminated on the FI-2 Board. (Figure 8)

1. Confirm power is disconnected from the ZC.
2. Route wire.
3. Cut to length and strip as appropriate.
4. Insert stripped wire into terminal. (It may be necessary to press the terminal release button to insert stranded wire)
5. Repeat for each wire.

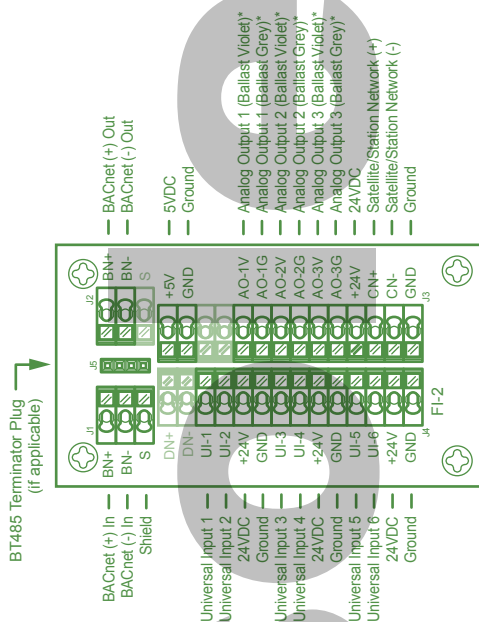

*Applicable on ZC with 0-10VDC Dimming Controller Option only.

(Figure 8)

Universal Input Specifications

Universal Input: 6 two-wire inputs

Universal Input Software Configuration:

- Digital Input (DI): maintained, state-change, momentary on/off, momentary on/dim up, or momentary off/dim down
- Analog Input (AI): 0-5VDC, 0-10VDC, or 4-20mA

Universal Input Power: 24VDC, 100mA total for all 6 UI

Universal Input Wire Requirement / Maximum Length: 18AWG (Solid or Stranded) / 500' (152m)

Universal Input DI Configuration (Two Button Low Voltage Switch)

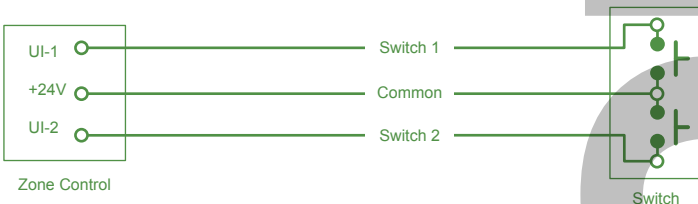

Universal Input DI Configuration (3-Wire 24V Occupancy Sensor)

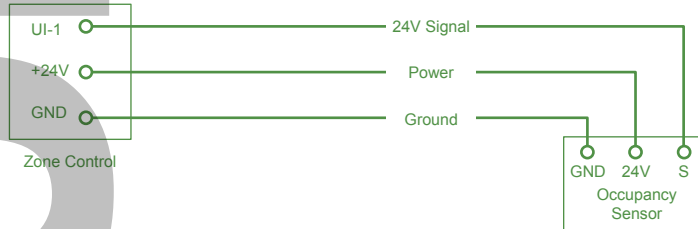

(Figure 9)

Terminations : Low Voltage Universal Input Continued

Universal Input DI Configuration (4-Wire 24V Occupancy Sensor)

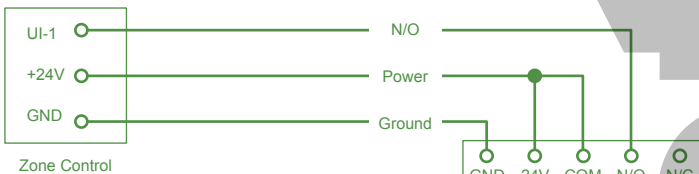

Universal Input DI Configuration (Externally Powered 4-Wire 24V Occupancy Sensor)

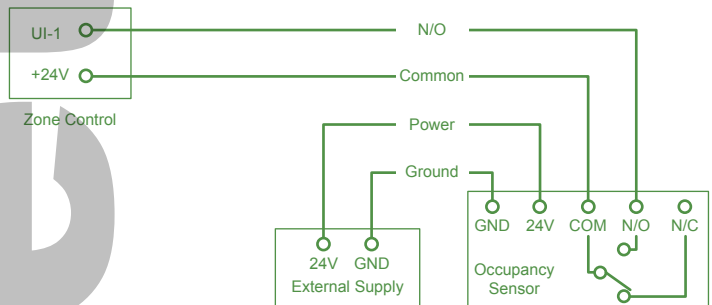

Universal Input AI Configuration (5V Light Sensor)

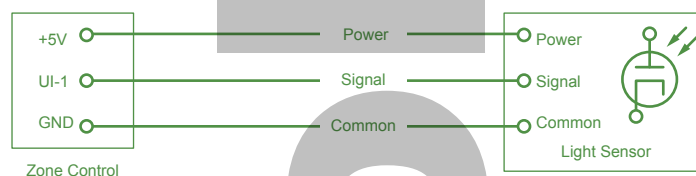

(Figure 10)

Analog Output Specifications*

Description: 2 on ZC Standard, 3 on ZC Extended

Compatibility: 0-10VDC dimming ballasts, Advance Mark VII

Sink: Up to 100mA on each (Source up to 5mA on each AO)

Wire Requirement / Maximum Length: 18AWG (Solid or Stranded) / 1,000' (304m)

Analog Output (Fluorescent 0-10VDC Dimming Ballast)

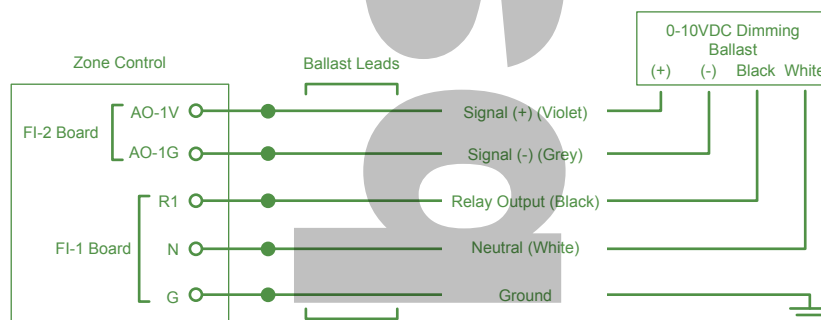

(Figure 11)

*See 0-10VDC Ballast Test Procedure document or page 11 of this Install Guide for ballast testing and trouble shooting instructions.

Terminations : Low Voltage

BAS Network Specifications*

Protocol: BACnet MS/TP, DIP switch selectable baud rates 9.6K, 19.2K, 38.4K, and 76.8K
 Device Profile: BACnet Advance Application Controller (AAC)
 Address Range: 1-99 selectable with rotary dials
 Unit Load: Full unit load, 32 devices per MS/TP segment
 Topology: RS-485, 3 conductor (+, -, and shield), daisy chain wiring (no stars or t-taps)
 Wire Requirement / Maximum Length: Belden 8760 / 4000'(1216m)

Install BT485 Terminator if ZC is operated as end of line device(first or last device on network). BT485 Terminator requires no specific orientation in relation to the J5 terminal.

See CB Setup for Address and Protocol settings.

BACnet MS/TP Network (Input and Output)

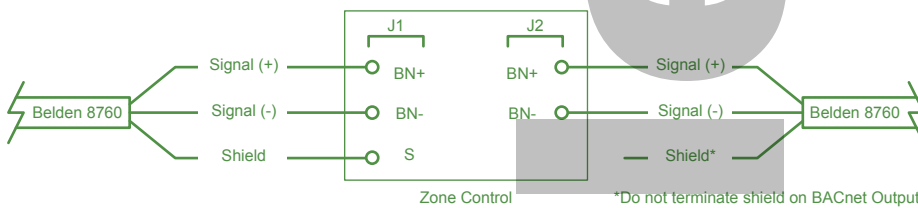

BACnet MS/TP Network (End-of-line Device)

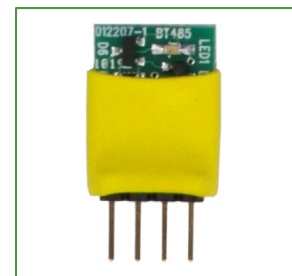
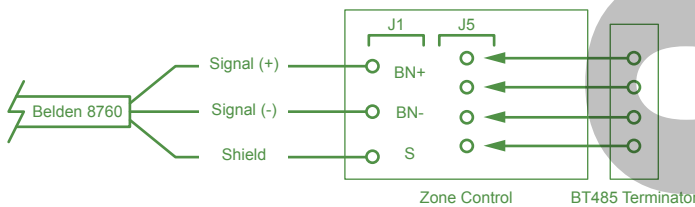

BT485 Terminator

(Figure 12)

Satellite / Station Network Specifications**

Protocol: CAN-bus
 Maximum Satellite Control (SC): 3 on ZC Standard, 7 on ZC Extended
 SC Address: Rotary dial selectable
 Maximum Stations (CTS): 6 on ZC Standard, up to 12 on ZC Extended (requires 1 SC minimum)
 CTS Address: DIP switch selectable
 Topology: Free topology, stars and t-taps allowed
 Wire Requirement / Maximum Length: CL3P, 22AWG, 4 conductor, Unshielded / 500'(152m)

See CB Setup for CAN network jumper settings.

Satellite / Station Network (ZC to CTS)

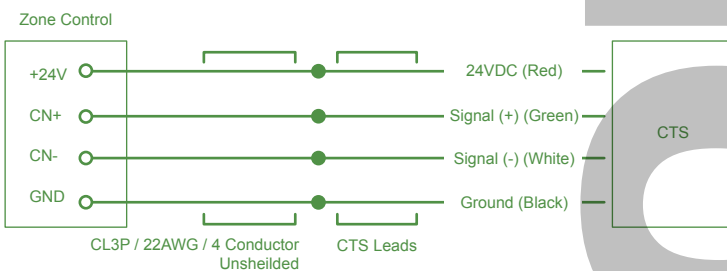

Satellite / Station Network (ZC to SC)

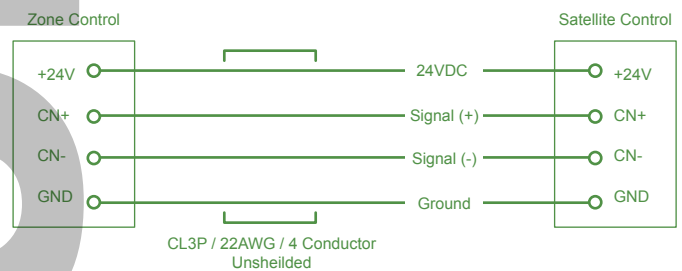

(Figure 13)

*See Application Guide and PIC Statement for BACnet points list.
 **See SC or CTS install guide for related installation instructions.

Reassembly

Following completion of wire terminations reassemble the ZC. (Figure 14)

1. Confirm power is disconnected from the ZC.
2. Install the Exclusion Frame in the LMF.
3. Replace Cover Assembly and tighten fasteners on the right side of the ZC.¹
4. Reconnect the ribbon cables to the CB.

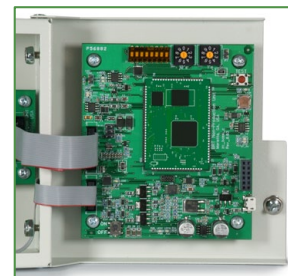
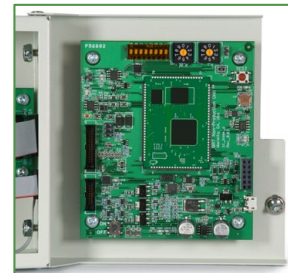
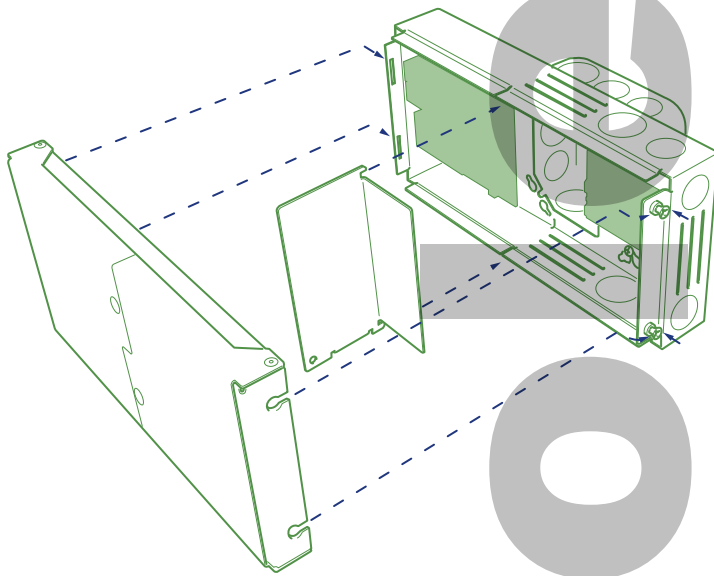

(Figure 14)



¹ When replacing the Cover Assembly ensure the Cover Assembly tabs (left side) are engaged with the slots on the LMF before aligning the fasteners (right side).

CB Setup

CB configuration and ZC testing are the final steps of installation. (Figure 15)

- Setup
1. Ensure Power Switch is in the "OFF" position, the USB cable is disconnected, and the Power / Run LED's are not illuminated.
 2. Set the CAN Network Terminator Jumper if utilizing Satellite / Station Network. Two devices on the Satellite / Station Network should be set for network termination. If ZC is the end-of-line, terminate ZC and the device at the end of the longest run. If ZC is positioned at a mid-point on the network, terminate devices at the end of the longest runs either side of ZC.
 3. Set the Programing / Protocol Dip Switch for protocol and baud rate.
 4. Set the Network Address.
 5. Install the Bluetooth module.

Testing

1. Move the Power Switch to the "ON" position.
2. Confirm normal LED operation.
Power LED: Solid illumination
Run LED: 1 blink per second
3. Press and release the Test Button. Confirm the following events.
Relays turn on.
Analog Outputs raise lighting to full output.
4. Press and release the Test Button again. Confirm the following events.
Relays turn off.
Analog Outputs lower lighting to off.
5. Test procedure complete.

Controller Specifications

Platform: Aperio Open Control Platform
 Time Clock: Real-time clock with BACnet time synch
 Schedule: BACnet Schedule, Monday – Sunday, Holidays, and Exceptions
 Non-Volatile Memory: 16MB total, 2MB for trend data (15min trend requires 2K per day)
 RAM: 2MB total, data stored in non-volatile memory upon power loss
 Configuration Port: Micro-USB
 Configuration Software: Aperio
 Wireless Port: Optional Bluetooth v2.0+EDR Class 1, PTP connection for configuration
 Wireless Port Range: Open air 328' (100m)
 Wireless Port Compatibility: Aperio on Bluetooth enabled computer (API available from Blue Ridge for interface development)

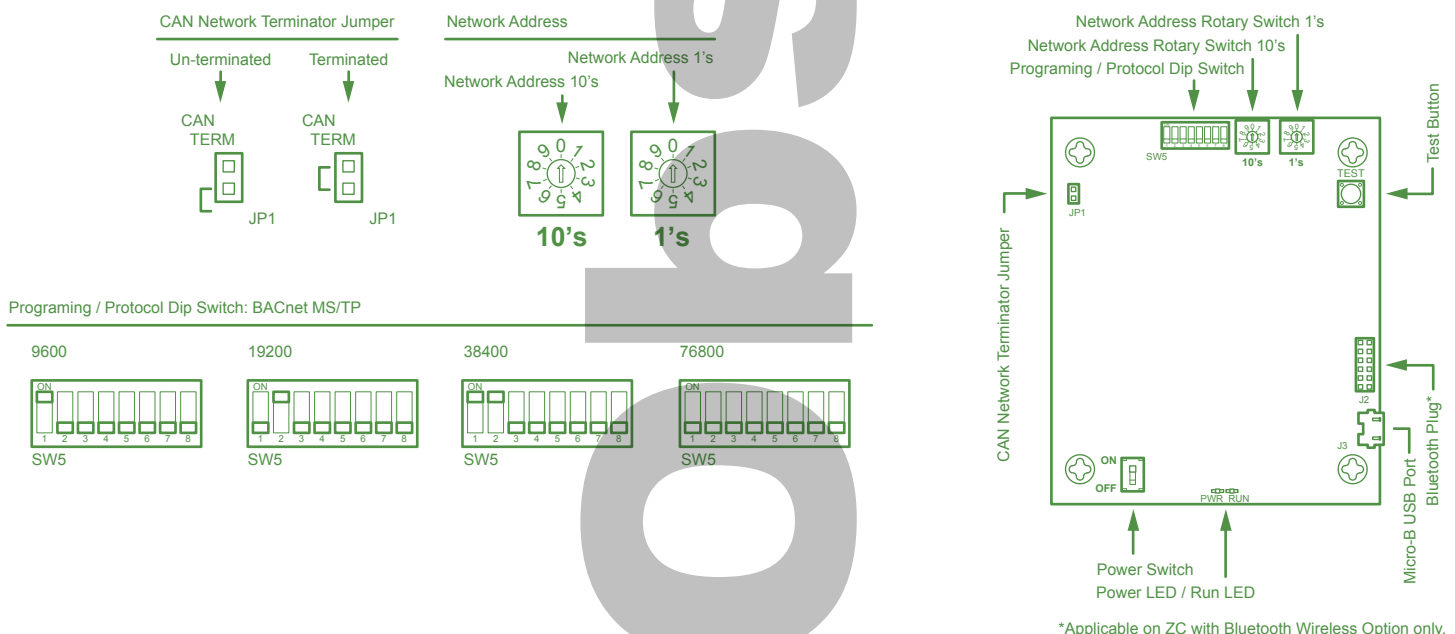

(Figure 15)

0-10VDC Ballast Test Procedure

Prior to the following tests, the installer should review *Philips Advance Linear Fluorescent Dimming Ballast Guide: A Pocket Guide to Installation and Troubleshooting** or a similar guide from the 0-10VDC dimming ballast manufacturer. Before connecting the 0-10VDC ballast control leads to the Blue Ridge Zone Controller (ZC) or Satellite Controller (SC), the installer must verify the following.

Part 1: At Each Ballast

1. Verify that 10VDC is measured between the Violet and Grey control leads.
A reading other than 10VDC (+ or – 1%) may indicate a defect in the ballast, an open control lead, or a shorted control lead. Resolve before continuing the test procedure.
2. If proper voltage is measured at the ballast control leads, short the Violet and Grey control leads together and confirm that the lamps dim to the minimum level for that ballast.
Lamps that do not dim to the minimum level may indicate a defective lamp, a miss wired lamp socket, a defective ballast, or a miss wired control lead. Resolve before continuing the test procedure.
3. Then, un-short the Violet and Grey control leads and confirm that the lamps achieve full light output.
Lamps that do not achieve full light output may indicate a defective lamp, a miss wired lamp socket, a defective ballast, or a miss wired control lead. Resolve before continuing the test procedure.
4. Finally, connect the control leads of all the ballasts that belong to the same channel making sure to maintain polarity throughout. All Violet colored control leads shall be connected together, and all Grey colored control leads shall be connected together. Stars and t-taps are allowed.

Part 2: At the Blue Ridge Zone Controller (ZC) or Satellite Controller (SC)

1. Verify that 10VDC is measured between the Violet and Grey control leads.
A reading other than 10VDC (+ or – 1%) may indicate a defect in the ballast, an open control lead, or a shorted control lead. Resolve before continuing the test procedure.
2. If proper voltage is measured at the end of the control leads, short the Violet and Grey control leads together and confirm that the lamps dim to the minimum level for that ballast.
Lamps that do not dim to the minimum level may indicate a defective lamp, a miss wired lamp socket, a defective ballast, or a miss wired control lead. Resolve before continuing the test procedure.
3. Then, un-short the Violet and Grey control leads and confirm that the lamps achieve full light output.
Lamps that do not achieve full light output may indicate a defective lamp, a miss wired lamp socket, a defective ballast, or a miss wired control lead. Resolve before continuing the test procedure.
4. Finally, connect the end of the control leads to the Controller making sure to maintain polarity at the terminals. The Violet colored control leads shall be connected to AO-1V, AO-2V, or AO-3V, and the Grey colored control leads shall be connected to AO-1G, AO2G, or AO-3G

The End - Test Procedure is Complete

Isolating Control Lead Wiring Errors or Defective Ballasts

Start by splitting the control lead wiring into two equal sections by disconnecting the Violet and Grey control leads. Then on each section, execute Part 2 of the Test Procedure to determine what section is good and what section is bad. Repeat the splitting process until the exact ballast or wiring error is isolated.