

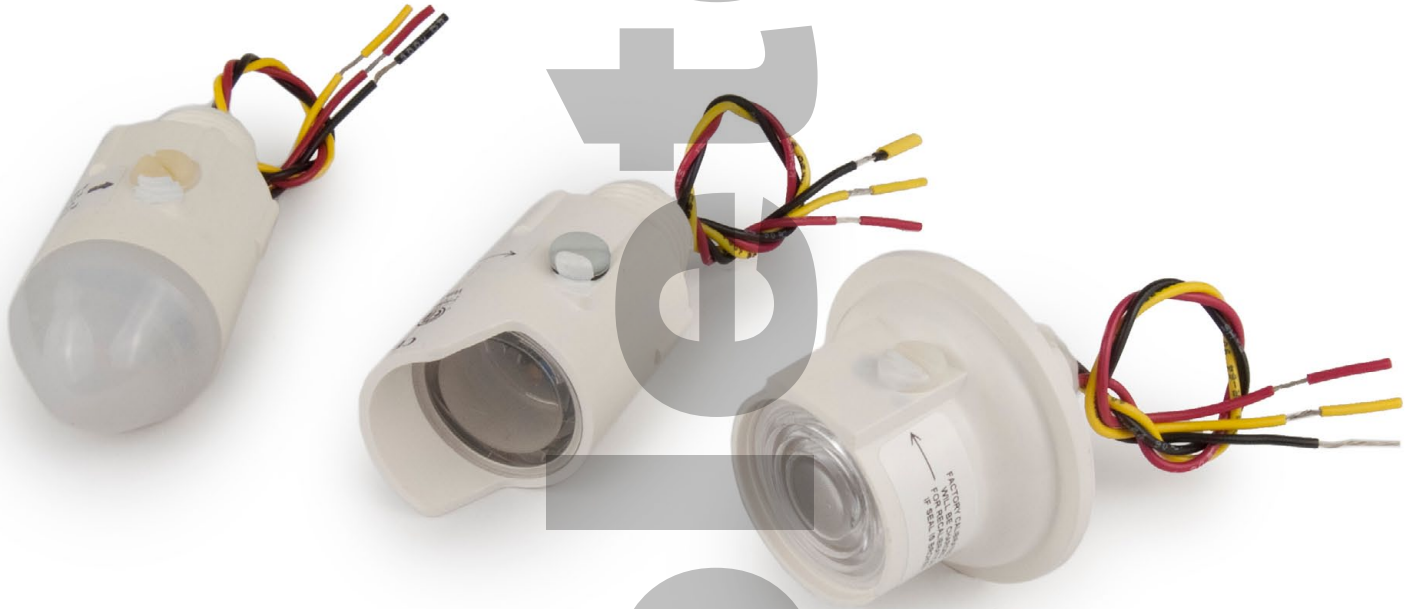





Hardware Connection Instructions



Attention

This section serves as a notice of the immediate or potential dangers involved when working with the equipment described throughout this manual. Any person involved in installation, maintenance, or service of the equipment should first carefully examine the equipment and read the instructions contained in this manual to ensure that personal and/or equipment injury is avoided.

The following safety messages appear throughout this manual to alert of immediate or potential danger to life as well as property.

	NOTE : Indicates an important note.
	TIP : Indicates a helpful tip or trick.
	SAFETY REMINDER : Applicable safety instructions will be included with this symbol.
	DANGER : Indicates an immediately hazardous situation which, if not avoided, will result in serious injury or death.
	WARNING : Indicates a potentially hazardous situation which, if not avoided, may result in serious injury or death.
	CAUTION : Indicates a potentially hazardous situation which, if not avoided, may result in minor or moderate injury.

Disclaimer

This equipment has been tested and found to comply with the limits for a Class A digital device, pursuant to part 15 of the FCC Rules. These limits are designated to provide reasonable protection against harmful interference when the equipment is operated in a commercial environment. This equipment generates, uses, and can radiate radio frequency energy and, if not installed and used in accordance with the instruction manual, may cause harmful interference to radio communications. Operation of this equipment in a residential area is likely to cause harmful interference, in which case the user will be required to correct the interference at his own expense.

Instructions contained in this user's guide should be performed only by qualified persons in accordance with local and national codes. Blue Ridge Technologies International, LLC and its affiliates assume no responsibility for any consequences related to the improper use of this manual.

Document Overview

This document provides connection instructions for the following Blue Ridge Technologies Light Sensor (LS5) products :

- LS5-A Atrium Sensor
- LS5-I Indoor Sensor
- LS5-O Outdoor Sensor
- LS5-S Skylight Sensor

These LS5 models are compatible with Retrofit Interior (RI), Retrofit Kit (RK), Relay Panel (RP), Satellite Control (SC), and Zone Control (ZC). For LS5 software configuration refer to the Application Guide.

Additional third party documentation is included for detailed specifications and instructions.

Identification

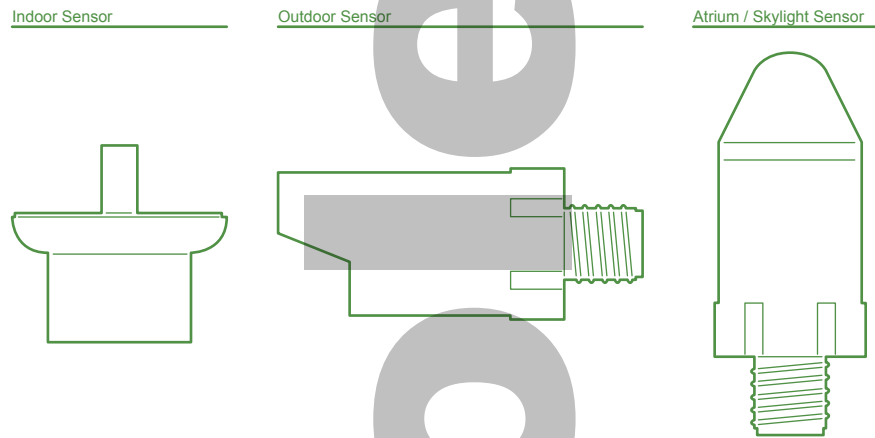

(Figure 1)

Connection

Electrical Specifications

- Power Input / Draw: 5VDC / 4.8mA
- Leads: 6"(152mm)L, 18AWG, 3-wire
- Red: 5VDC
- Black: Common
- Yellow: Signal

Wire Requirement / Maximum Length

- RK / RI / RP Analog Input: 18AWG (Solid or Stranded) / 250'(76m)
- SC / ZC Universal Input: 18AWG (Solid or Stranded) / 500'(152m)

RI / RK / RP Controller Terminations

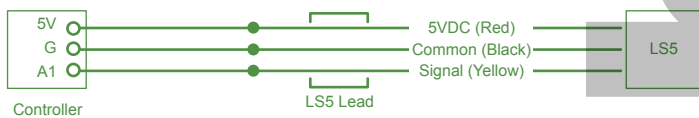

ZC / SC Terminations

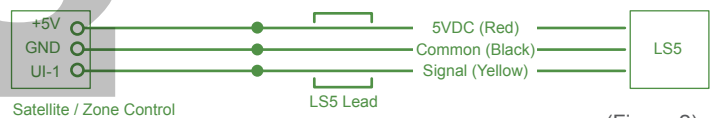

(Figure 2)



Disconnect power before performing LS5 installation.
All circuits must be tested for wiring errors and shorts prior to LS5 installation.