



Capacitive Touch Station DDN

www.BRTint.com : 800-241-9173 Blue Ridge Technologies® © 2012 Blue Ridge Technologies International, LLC All Rights Reserved. BR-CTSDDN-IG-V11.00

Install Guide : Page 1

Hardware Installation and Setup Instructions

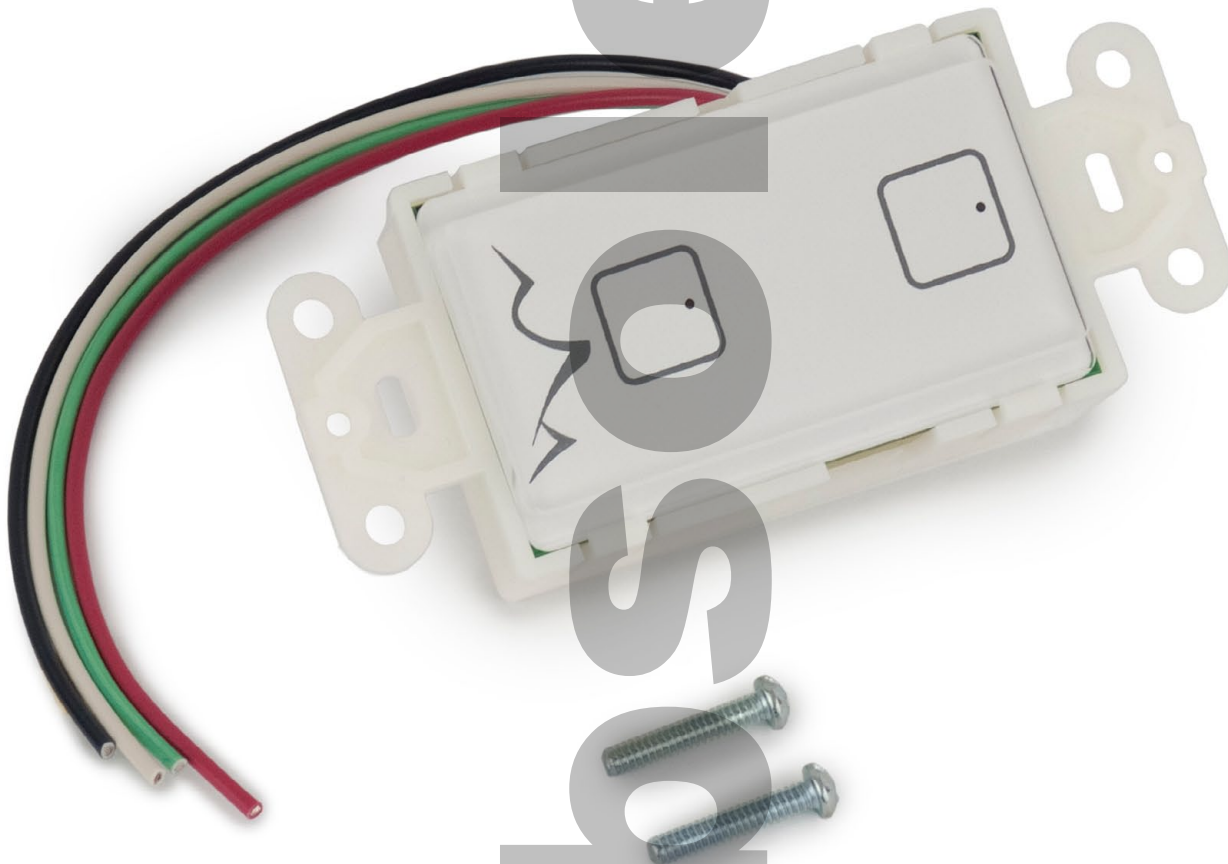

Table of Contents







Overview	
Document	3
Component	3
Assembly	3
Station Setup	3
Connection	4
Testing	4
Mounting	4

Visit www.BRTint.com/tandc.html for Terms and Conditions of Sale

Attention

This section serves as a notice of the immediate or potential dangers involved when working with the equipment described throughout this manual. Any person involved in installation, maintenance, or service of the equipment should first carefully examine the equipment and read the instructions contained in this manual to ensure that personal and/or equipment injury is avoided.

The following safety messages appear throughout this manual to alert of immediate or potential danger to life as well as property.

	NOTE : Indicates an important note.
	TIP : Indicates a helpful tip or trick.
	SAFETY REMINDER : Applicable safety instructions will be included with this symbol.
	DANGER : Indicates an immediately hazardous situation which, if not avoided, will result in serious injury or death.
	WARNING : Indicates a potentially hazardous situation which, if not avoided, may result in serious injury or death.
	CAUTION : Indicates a potentially hazardous situation which, if not avoided, may result in minor or moderate injury.

Disclaimer

This equipment has been tested and found to comply with the limits for a Class A digital device, pursuant to part 15 of the FCC Rules. These limits are designated to provide reasonable protection against harmful interference when the equipment is operated in a commercial environment. This equipment generates, uses, and can radiate radio frequency energy and, if not installed and used in accordance with the instruction manual, may cause harmful interference to radio communications. Operation of this equipment in a residential area is likely to cause harmful interference, in which case the user will be required to correct the interference at his own expense.

Instructions contained in this user's guide should be performed only by qualified persons in accordance with local and national codes. Blue Ridge Technologies International, LLC and its affiliates assume no responsibility for any consequences related to the improper use of this manual.

Overview : Document

This document provides mounting and connection instructions for the following Blue Ridge Technologies Capacitive Touch Station (CTS-DDN) products :

- CTS-DDN Channel On-Off 1-Button Stations
- CTS-DDN Channel On-Off 2-Button Stations

These CTS-DDN models are compatible with the DDN Network on Retrofit Interior (RI), Retrofit Kit (RK), and Relay Panel (RP).

Sections of this Install Guide apply to optional equipment and may not be applicable.

For CTS-DDN software configuration refer to the Application Guide.

Overview : Component

The CTS-DDN includes the following items :

- 1- CTS-DDN
- 2- #6/32 Screws

Overview : Assembly

- 1. Reset Button
- 2. Wall Plate Fastener Point
- 3. Mounting Fastener Point
- 4. Capacitive Touch Button
- 5. DIP Switch
- 6. CTS-DDN Leads

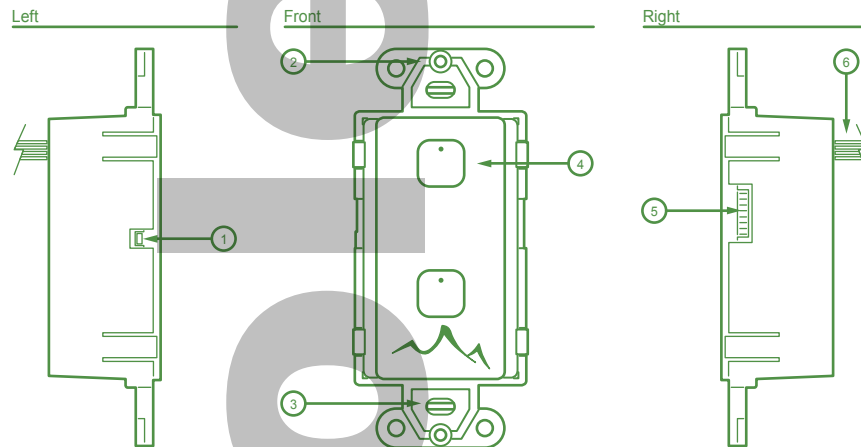

(Figure 1)

Station Setup

CTS-DDN hardware setup is best performed before mounting the station.

(Figure 2)

1. Addressing: Each CTS-DDN button must have a unique address on the DDN Network. Utilize DIP Switches 1-6 to set the address. (See Address Setting Chart) On 2-button stations the DIP Switch sets the address for the top button while the station automatically applies the address + 1 for the bottom button. For example, if address 3 is applied the top button the bottom button is automatically set to address 4.
2. Mode: Ensure DIP Switch 7 is in the "On" position.
3. Network Termination: Two devices on the DDN Network should be set for network termination. If the Controller is the end-of-line, terminate the Controller and the device at the opposite end of the network. If the Controller is positioned at a mid-point on the network, terminate devices at the opposite ends of the network either side of the Controller. To terminate CTS-DDN set DIP Switch 8 in the "On" position.

Address Setting Chart

Address	Switches "On"	Address	Switches "On"	Address	Switches "On"
1	1	21	1,3,5	41	1,4,6
2	2	22	2,3,5	42	2,4,6
3	1, 2	23	1,2,3,5	43	1,2,4,6
4	3	24	4,5	44	3,4,6
5	1,3	25	1,4,5	45	1,3,4,6
6	2,3	26	2,4,5	46	2,3,4,6
7	1,2,3	27	1,2,4,5	47	1,2,3,4,6
8	4	28	3,4,5	48	5,6
9	1,4	29	1,3,4,5	49	1,5,6
10	2,4	30	2,3,4,5	50	2,5,6
11	1,2,4	31	1,2,3,4,5	51	1,2,5,6
12	3,4	32	6	52	3,5,6
13	1,3,4	33	1,6	53	1,3,5,6
14	2,3,4	34	2,6	54	2,3,5,6
15	1,2,3,4	35	1,2,6	55	1,2,3,5,6
16	5	36	3,6	56	4,5,6
17	1,5	37	1,3,6	57	1,4,5,6
18	2,5	38	2,3,6	58	2,4,5,6
19	1,2,5	39	1,2,3,6	59	1,2,4,5,6
20	3,5	40	4,6	60	3,4,5,6

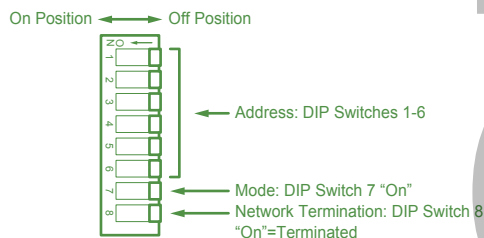

(Figure 2)



Disconnect power before performing CTS-DDN installation.



Before handling any CTS-DDN components, the technician should be grounded to prevent circuit board damage.

Connection

CTS-DDN is now ready to be connected to the DDN Network. (Figure 3)

1. Test the DDN Network for wiring errors, shorts, and proper voltage before connecting CTS-DDN.
2. Disconnect power from the switch box.
3. Connect CTS-DDN leads to network.

Low Voltage Specification

Power: 24VDC from RI, RK, or RP
Power Draw: 15mA per CTS-DDN

DDN Network Specifications

Protocol: Digital Device Network (DDN)
Maximum Stations (w/o external power): 10 CTS-DDN
Maximum Stations (w/ external power): 60 one-button, 30 two-button, or a combination for 60 buttons total
Address Range: 1-60, DIP switch selectable
Topology: Daisy Chain Wiring (no stars or t-taps)
Wire Requirement: CL3P, 22AWG, 4 conductor, Unshielded
Maximum Length (w/o external power): 500'(152m)
Maximum Length (w/ external power): 2,000'(610m)
External Power: A 24VDC Power Supply is required for every 10 CTS-DDN or 500'(152m) of network length.

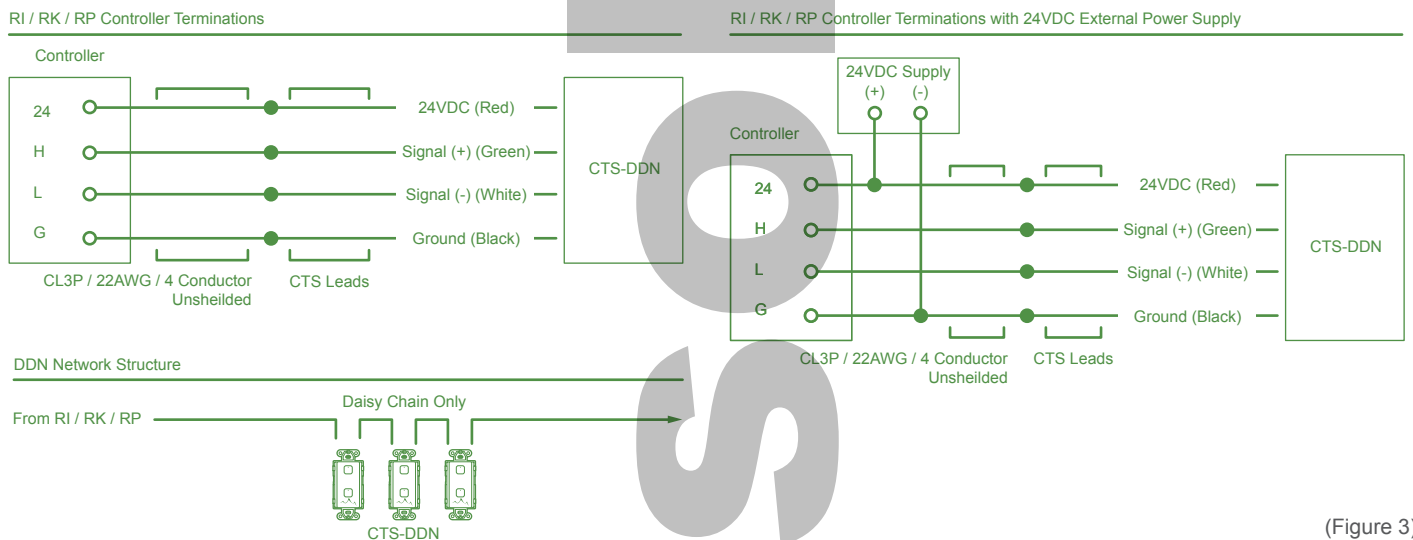

(Figure 3)

Testing

Test CTS-DDN for power prior to mounting.¹

1. Connect power to the CTS-DDN.
2. Press an On/Off button to confirm the station emits an audible chirp.
3. In the event the chirp is not audible confirm power by way of the Power LED. When power is connected the LED will illuminate solid green. The LED is visible from a small opening atop the CTS-DDN back box. (Figure 4)

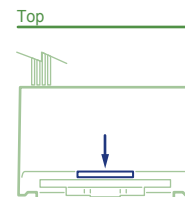

(Figure 4)

Mounting

CTS-DDN is now ready to be mounted to the switch box.

1. Position CTS-DDN in the switch box.
2. Fasten to switch box with the 2 provided #6/32 screws.
3. Install cover plate.

General Specifications

Mounting: Standard single gang or multi-gang switch box, (2) #6/32 screws (included), and Decorator style wall plate (not included)



¹ If an address has not been set for the station's buttons the LED's on the front of the station will blink in an alternating pattern followed by a pause. To resolve this error set the desired address then press and release the Reset Button.