

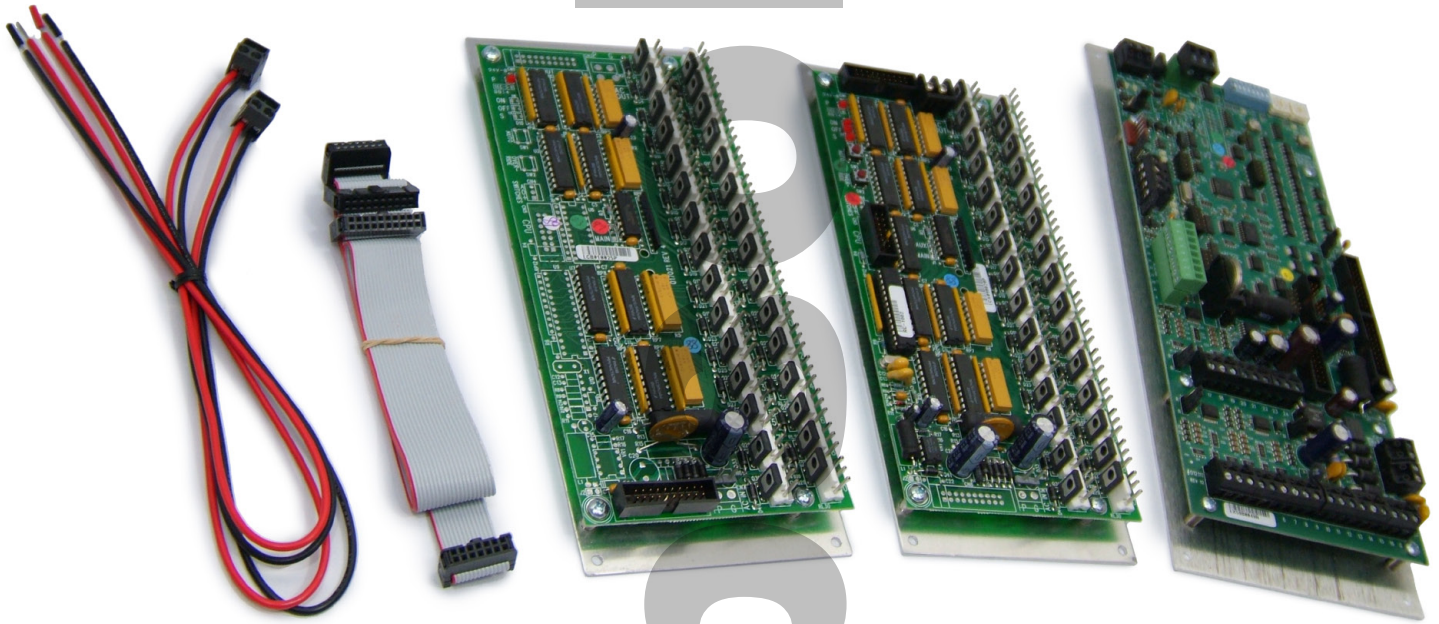

BR Series Retrofit Kit 4

Mounting and Configuration Instructions

BR Series



Attention

This section serves as a notice of the immediate or potential dangers involved when working with the equipment described throughout this manual. Any person involved in installation, maintenance, or service of the equipment should first carefully examine the equipment and read the instructions contained in this manual to ensure that personal and/or equipment injury is avoided.

The following safety messages appear throughout this manual to alert of immediate or potential danger to life as well as property.



Note : Indicates an important note.



Tip : Indicates a helpful tip or trick.



Safety Reminder : Applicable safety instructions will be included with this symbol.



DANGER : Indicates an immediately hazardous situation which ,if not avoided, will result in serious injury or death.



WARNING : Indicates a potentially hazardous situation which ,if not avoided, may result in serious injury or death.



CAUTION : Indicates a potentially hazardous situation which ,if not avoided, may result in minor or moderate injury.

Disclaimer

This equipment has been tested and found to comply with the limits for a Class A digital device, pursuant to part 15 of the FCC Rules. These limits are designated to provide reasonable protection against harmful interference when the equipment is operated in a commercial environment. This equipment generates, uses, and can radiate radio frequency energy and, if not installed and used in accordance with the instruction manual, may cause harmful interference to radio communications. Operation of this equipment in a residential area is likely to cause harmful interference, in which case the user will be required to correct the interference at his own expense.

Instructions contained in this user's guide should be performed only by qualified persons in accordance with local and national codes. Blue Ridge Technologies International, LLC and its affiliates assume no responsibility for any consequences related to the improper use of this manual.

Table of Contents

Document Overview	4
Component Overview	
Retrofit Kit	5
Pigtail	6
Identification and Features	
RIB-A Relay Interface Board	7
RIB-B Relay Interface Board	8
Removing Existing Lighting Control System	9
Installation	
Overview	10
Component Placement	11
Mounting	12
Connections	
Ribbon Cable and RIB Power Pigtails	13
Relay	14
Network	15
Switches and Polarity	17
Analog Inputs	20
Digi-Touch	21
RK Power Connection	22
Additional Configurations	
RK4-L Overview	23
RK Configuration Worksheet	24

Visit <http://www.brtint.com/tandc.html> for Terms and Conditions of Sale

Document Overview

This document provides instructions for mounting and connection of the following Blue Ridge Technologies products :

RK4 Retrofit Kit
PT4 Pigtail

These instructions may also be applied to other RK4 configurations including :

RK4-L Retrofit Kit (Includes LEXP)

This Retrofit Kit is compatible with :
MicroLite Panels (MLR-020)
Johnson Controls ILC Panels (JCI-ILC)
Touch-Plate Panels (3000-PL and 4000-PL)

For Lx5 Controller hardware configurations refer to the Lx5 Hardware User Guide.

For advanced Lx5 Controller programming, including LPPK and AppLoader software instructions, refer to USB Tech Kit User Guide.

For Lx5 Controller integration with an Building Automation System (BAS) refer to the Lx5 Integration Guide.



Before handling any Retrofit Kit components, the technician should be grounded to prevent circuit board damage. Retrofit Kits are fragile handle with care.

Component Overview : Retrofit Kit

The RK4 includes the following items (Figure 1) :

- 1 - Lx5 Controller
- 1 - Relay Interface Board (RIB-A) with (30) outputs.
- 1 - Relay Interface Board (RIB-B) with (30) outputs.
- 2 - 2-Wire RIB Power Pigtails (17" Total Length).
- 1 - 14-Pin Ribbon Cable (18" Total Length).
- 1 - 20-Pin Ribbon Cable (31" Total Length).

For overview of RK4-L configuration (See page 23).

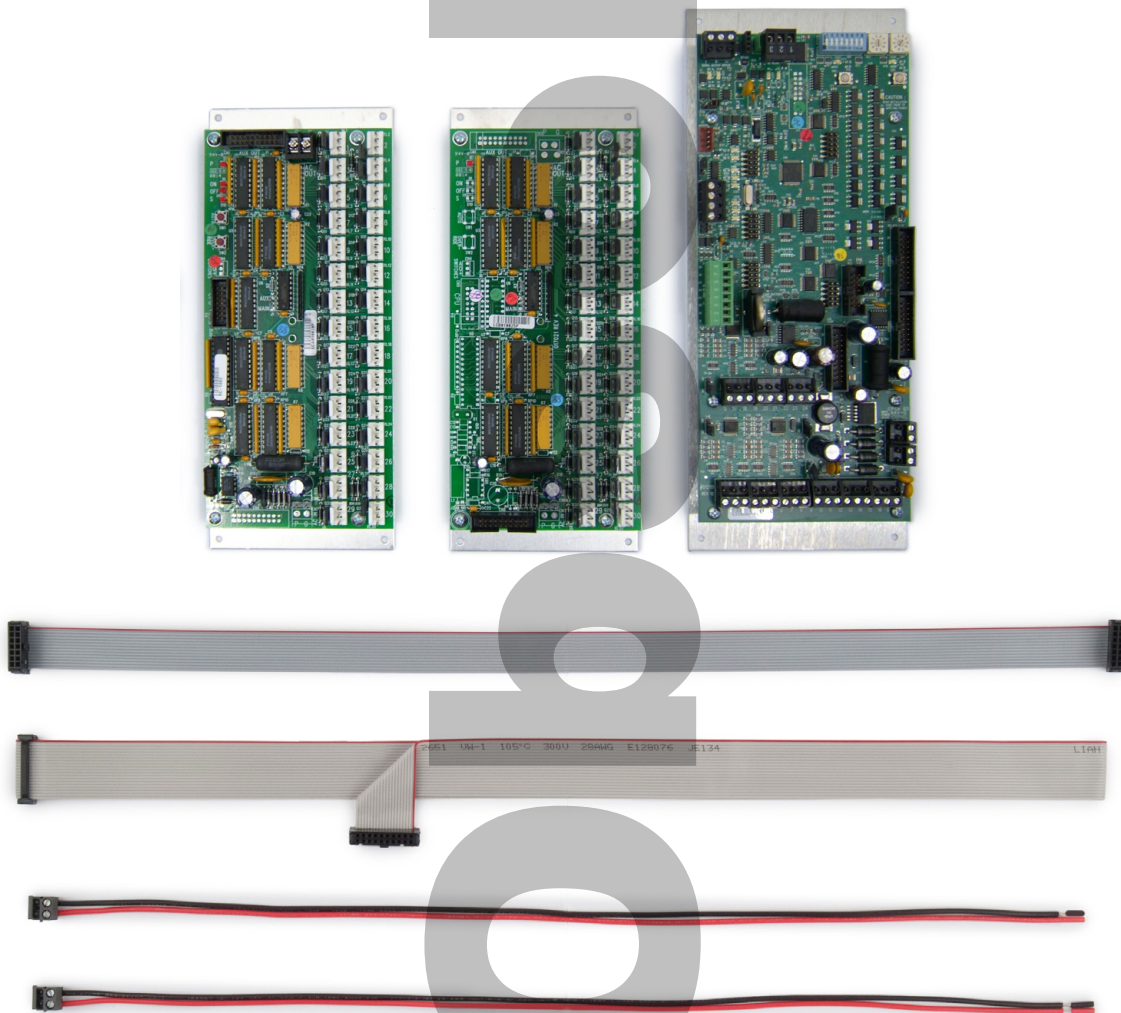

(Figure 1)

Component Overview : Pigtail

The PT4 Pigtail includes the following items (Figure 2) :*

- 1 - 4 Wire Pigtail 18" (RIB terminal and color coordinated wire)
- 1 – Single-U Insulation Displacement Connector (IDC)
- 3 – Double-U Insulation Displacement Connectors (IDC)



(Figure 2)

* Pigtails must be ordered during purchase of Retrofit Kit. Quantity must be specified.

Identification and Features : RIB-A

Retrofit Kits include two different styles of RIB with 30 relay outputs labeled 1-30. RIB-A commands outputs 1-30.

RIB-A Features Include : (Figure 3)

1. Power Input
2. 14-Pin Ribbon Cable Socket
3. Output Override Controls*
4. Power LED
5. 20-Pin Ribbon Cable Socket
6. Power Output

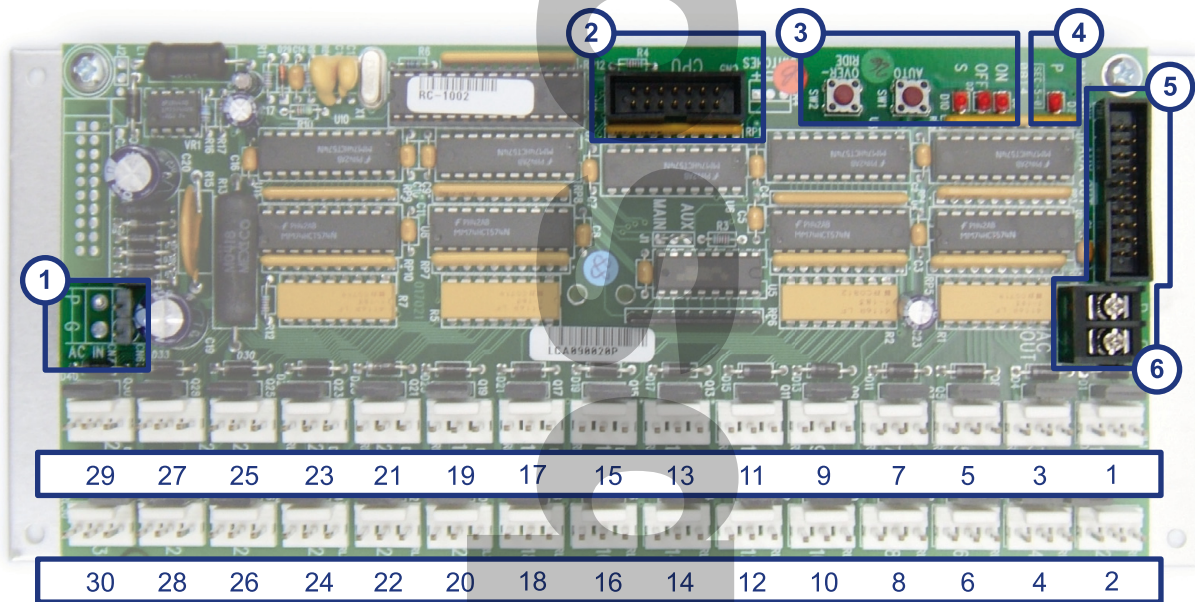

RIB-A (Outputs 1-30)

(Figure 3)

* Function of RIB-A Output Override Controls is identical to Controller Output Override Controls. Refer to the Component Description section of Lx5 Hardware User Guide for Output Override instructions.

Identification and Features : RIB-B

RIB-B controls outputs 31-60.

RIB-B Features Include : (Figure 4)

1. 20-Pin Ribbon Cable Socket
2. Power Input
3. Power LED

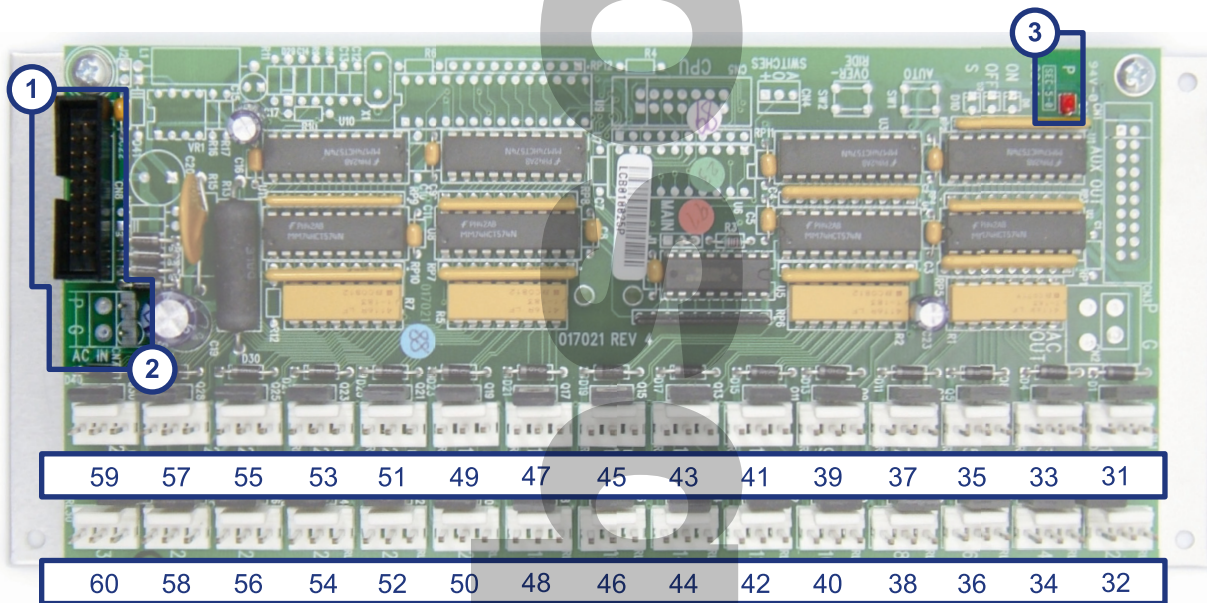

RIB-B (Outputs 31-60)

(Figure 4)

Removing Existing Lighting Control System

The existing control system must be removed to allow installation of the Retrofit Kit. ¹

1. Disconnect line voltage power from the panel.
2. Unfasten or cut existing low voltage wiring. Do not cut existing relay control wires too short. Wires may be cut to length later.
3. Unbolt and remove existing controller electronics.
4. Remove any dust or construction debris from low voltage bay of the panel.



¹ Disconnect line voltage power from the panel before performing Retrofit Kit installation.

Installation : Overview

Retrofit Kits permit soft-wiring Inputs to Outputs. This allows relays to be connected to any Output terminal on the RIB while maintaining the original system configuration.

Soft-wiring is achieved by a software based Grouping method. The Input (switches, occupancy sensors, light level sensors, etc) is assigned control of a Group. Each Group contains Outputs (relays and related lighting circuits). Therefore, an Input commands its assigned Group and all the Outputs contained within that Group. These Group assignments may be configured to suit any application ensuring maximum flexibility during physical installation.

Example :

Original Configuration

- Input 1 controls Relay 1

Retrofit Configuration

- Due to panel arrangement Relay 1 is in close proximity to Output 31 on RIB-B
- Therefore Relay 1 is connected to Output 31.
- During software configuration Input 1 is assigned control of Group 1 and Output 31 is placed in Group 1.
- The original configuration is maintained. Input 1 controls Relay 1 through Group 1.



Note each relay to output relationship while completing connections. This is essential for final software configuration. Connections may be recorded utilizing the RK Configuration Worksheet. (See page 24)

Refer to the USB Tech Kit User Guide for detailed LPPK software instructions including thorough explanations of the relationship of inputs and outputs through groups.

Installation : Component Placement

Retrofit Kit components may be arranged to suit various applications. Consider these factors while determining position of components. (Figure 5)

- Ensure the RIB's are near the relays with which they will interface.
- RIB position should minimize cross-board wiring (relay interface wires lying across boards).
- Ensure Controller is near the switch input leads.
- Confirm the distance between the Controller and RIB's does not exceed the length of the RIB Power Pigtails.
- Allow a minimum of 0.75" (20mm) clearance between component mounting plates for ease of wiring.

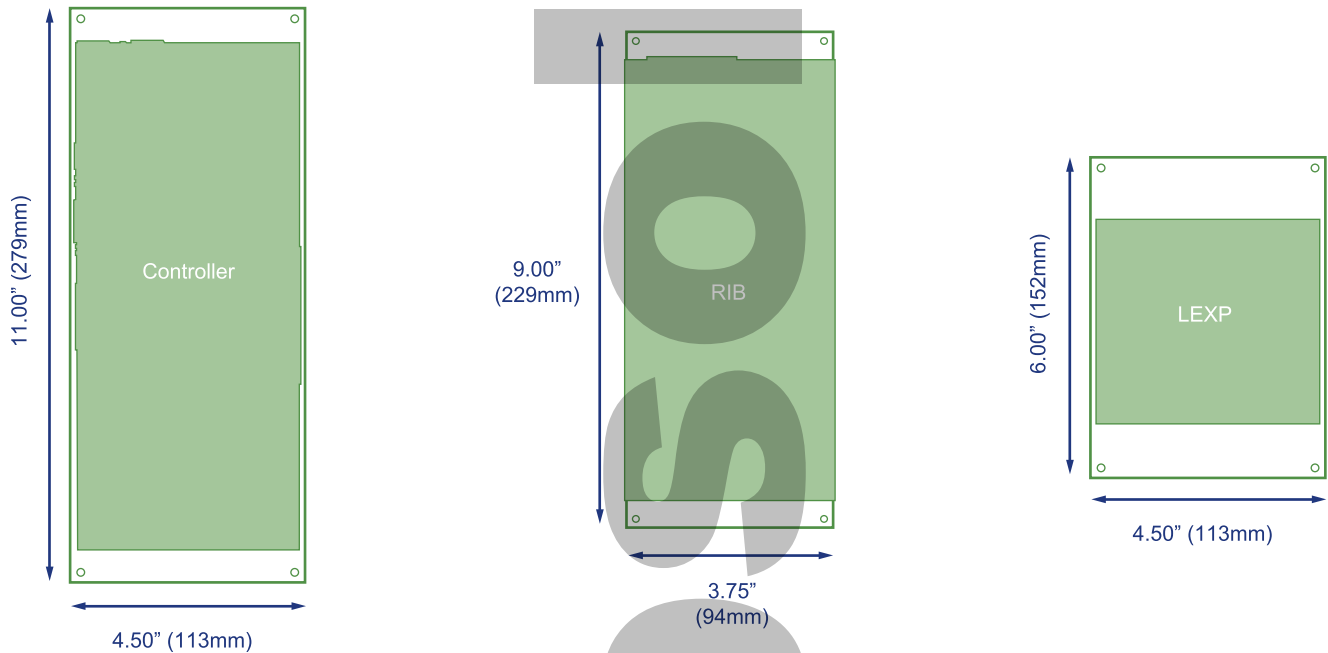

(Figure 5)

Installation : Mounting

The Retrofit Kit may now be mounted in the low voltage bay.

1. Determine position of all components prior to installation.
2. Fasten the Controller in position utilizing self-tapping screws. Drive a screw through each of the four holes in its aluminum mounting plate. Keep the board clear of any metal shavings. (Figure 6)
3. Repeat fastening procedure for each component required in the application.
4. Remove any metal shavings from the panel.

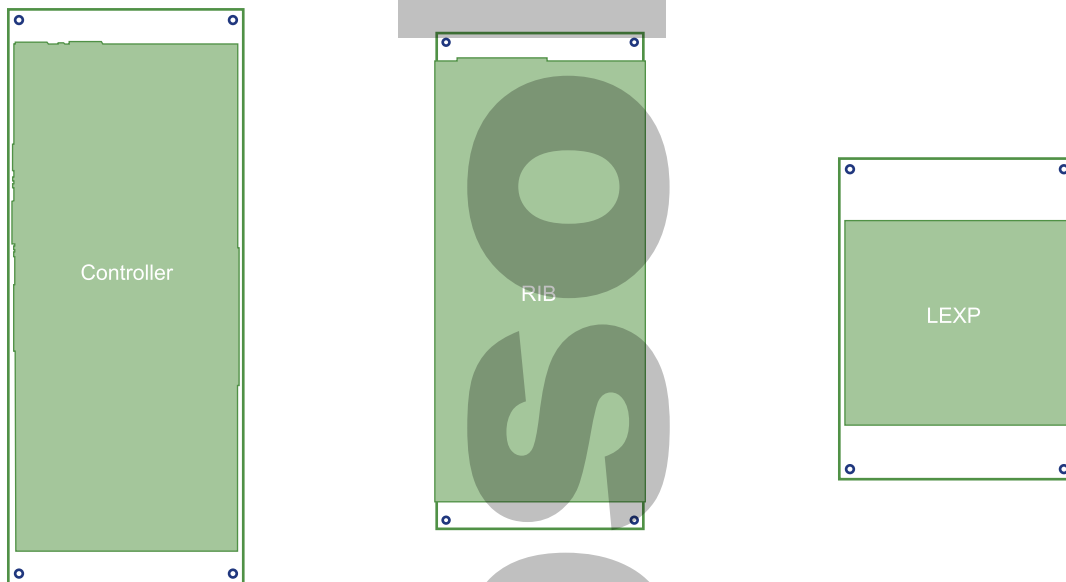

(Figure 6)

Connections : Ribbon Cable and RIB Power Pigtails

Install the Ribbon Cables and RIB Power Pigtails to make connections between the Controller and RIB's.¹ (Figure 7)

1. Confirm power is disconnected from the Controller.
2. Connect Controller and RIB-A utilizing the 14-Pin Ribbon Cable and a RIB Power Pigtail.
3. Connect RIB-A and RIB-B utilizing the 20-Pin Ribbon Cable and a RIB Power Pigtail.
4. If applicable connect cable to LEXP.
5. Ensure cables are routed in a neat fashion to prevent interference during remaining installation.

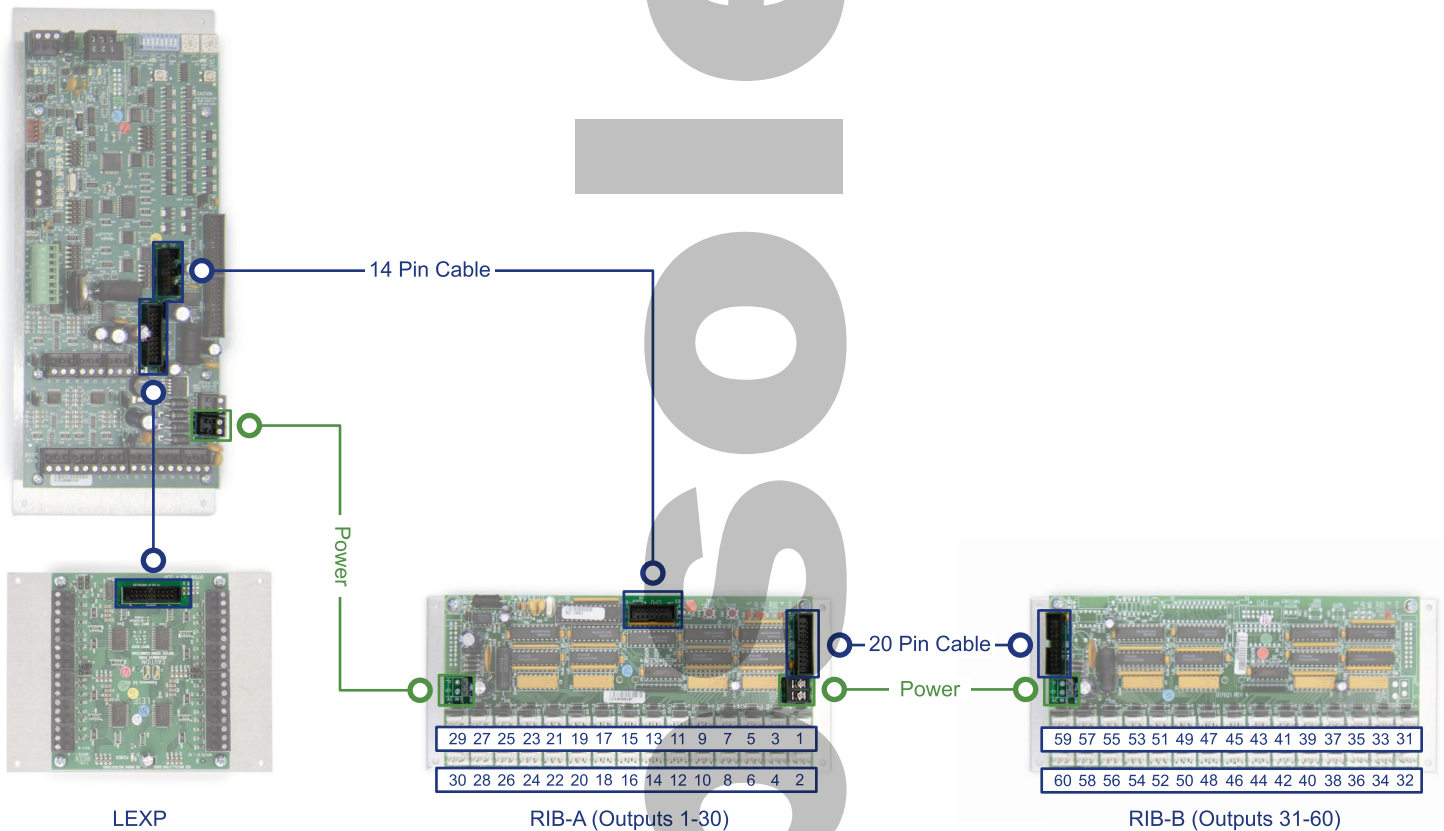

(Figure 7)



¹ Disconnect power to the Controller before installing or removing ribbon cables. Failure to do so could result in damage to the electronics and/or relays.



The ribbon cable plugs and mating sockets are keyed. Refer to the key to ensure correct orientation of each connection.

Connections : Relays

Each RIB is designed to interface with relays utilizing Pigtails.* Insulation Displacement Connectors (IDC) connect the relay wires to the pigtails.

1. Ensure the existing relay wires are of appropriate length to connect with Pigtails. Cut to length if desired.
2. Connect Pigtails and existing wires with IDC's. Refer to color coordination to confirm correct connection. (Figure 8)
3. Install Pigtail terminal on appropriate RIB pins. Confirm the connection's orientation. (Figure 9)
4. Repeat procedure for each relay.

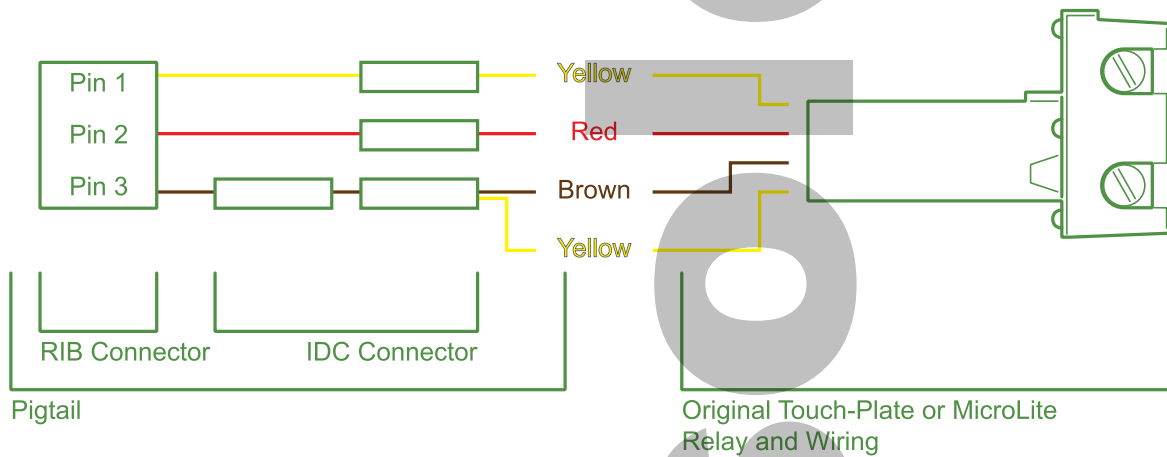

(Figure 8)

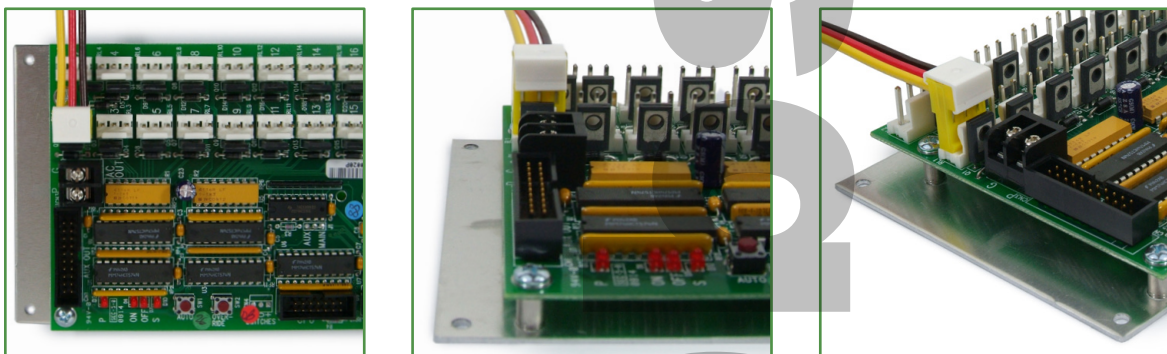

(Figure 9)



Note each relay to output relationship while completing connections. This is essential for final software configuration. Connections may be recorded utilizing the RK Configuration Worksheet. (See page 24)

* Pigtails must be ordered during purchase of Retrofit Kit. Quantity must be specified.

Connections : Network

The Controller is capable of being networked to a Building Automation System over a two or three wire EIA-485 communication network.

Wire Requirement : Belden 8760 or equivalent (4000 ft maximum)

1. Confirm power is disconnected from the Controller.
2. For ease of wiring remove the EIA-485 Terminal Block to reveal terminal labels. (Figure 10)
3. Connect incoming and outgoing communication wires (-) to (-) and (+) to (+) on the EIA-485 connector.
4. When a shield wire is used, terminate the incoming shield wire in the shield (S) terminal on the EIA-485 connector. Ensure the outgoing shield lead is disconnected and capped.
5. Reinstall the EIA-485 Terminal Block.

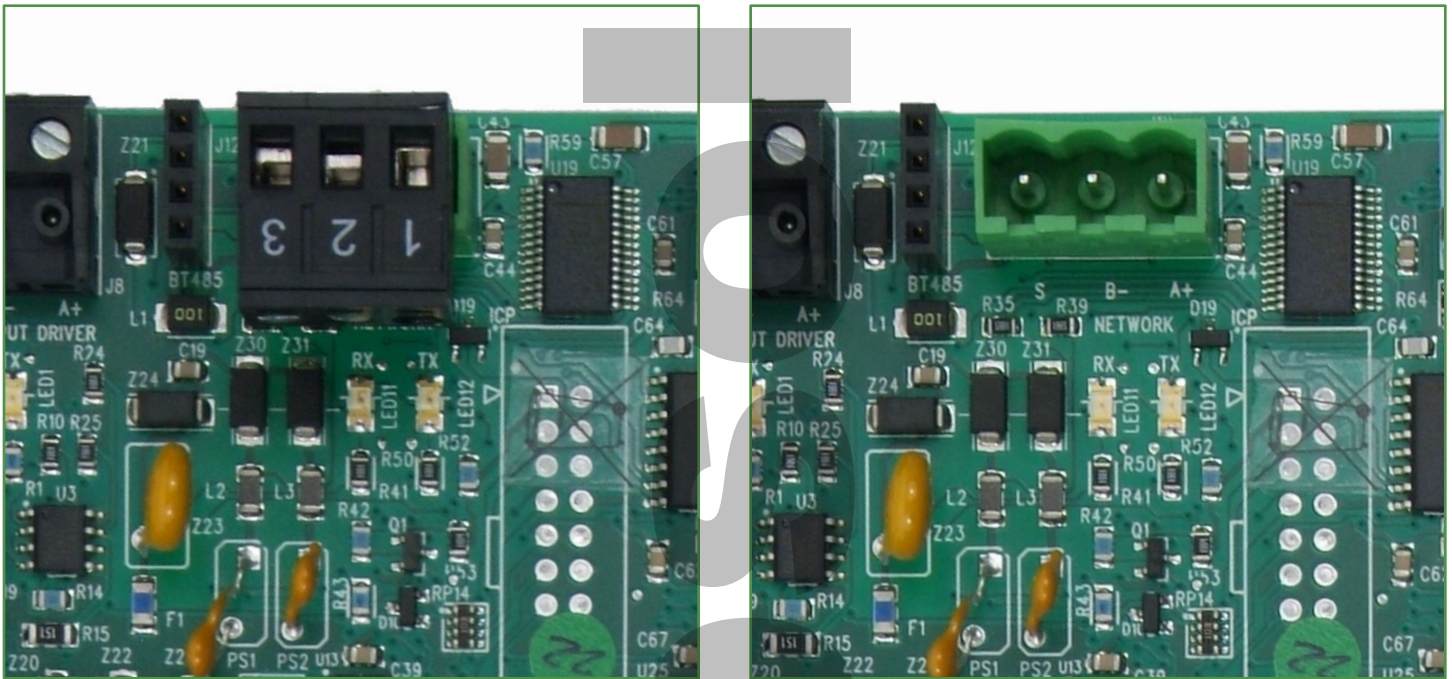

(Figure 10)

BACnet MSTP Network (Input)

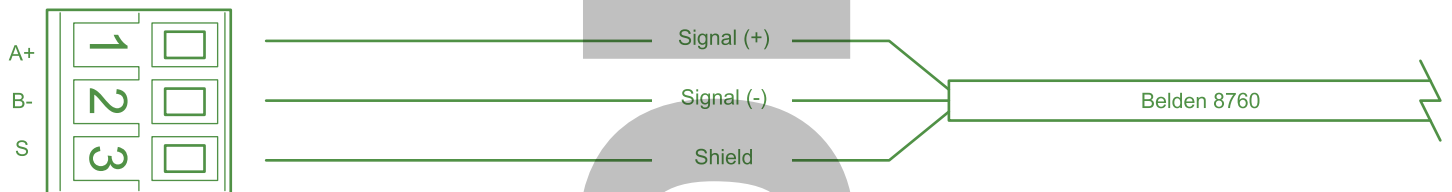

Connections : Network

If a Controller is operated as an End-of-line device (first or last controller on a network) provided part BT485 may be necessary. Consult Blue Ridge Technical Support prior to ordering and installation. (Figure 11)

1. Install BT485 in plug labeled BT485 adjacent to the EIA-485 terminal.

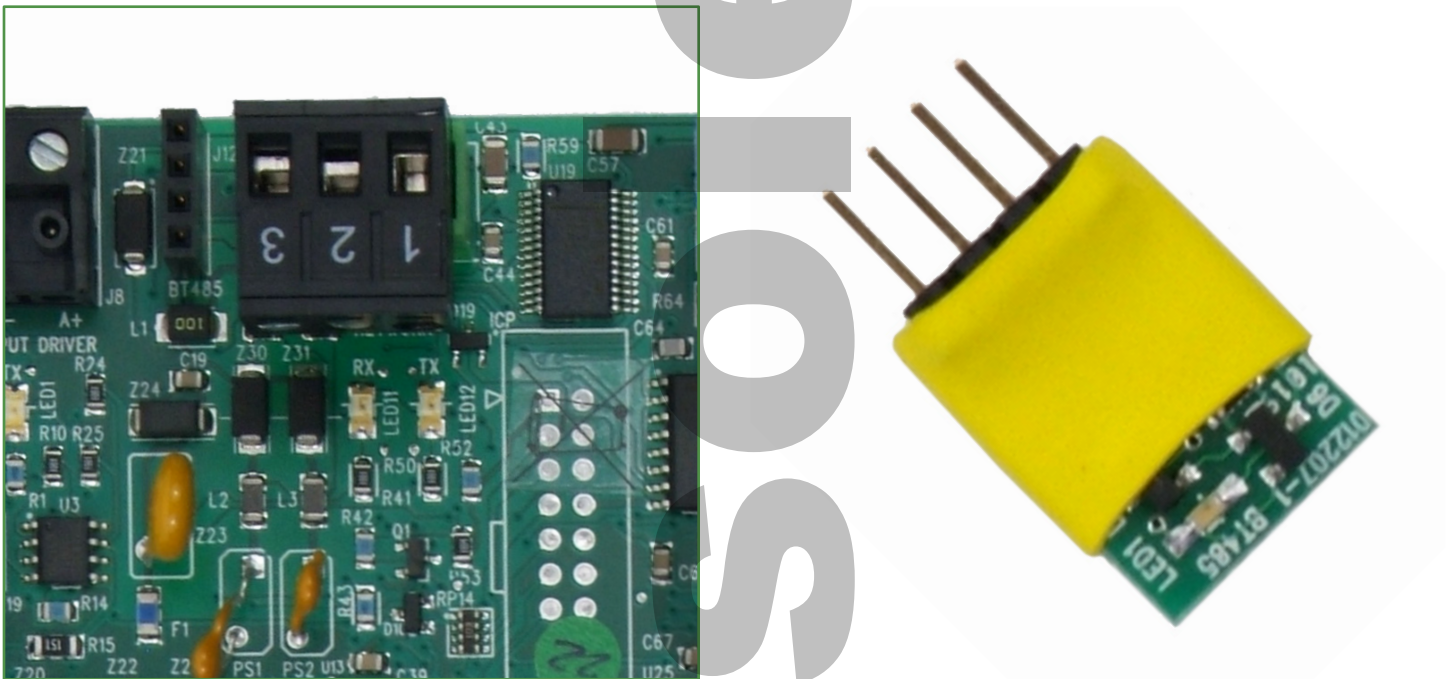

(Figure 11)



Older Tech Kits (with serial cable) will not communicate while BT485 is fitted.

Connections : Switches and Polarity

The Controller is equipped with 24 programmable switch inputs. The inputs are software configurable as Momentary on, Momentary off, Momentary on/off, Maintained, Linked, or State change. Each eight input section has an accompanying jumper that sets polarity (5 to 24 VDC or dry 0 VDC). Each jumper set has 3 pins allowing two positions. One position is labeled (N) normal polarity for dry contact switches (0 VDC). The second position entitled (R) reverse polarity for externally powered switches (5 to 24 VDC). The jumper must be set before wiring. (Figure 12) (See page 18 for Jumper location)

Optional LEXP Input Expansion Cards increase input capacity in increments of 32 inputs. LEXP is jumper addressed A, B, C, and D at the factory. Always power down the Controller before connecting or removing card.

Wire Requirement : 18 AWG (Solid or Stranded, non twisted, un-shielded wire only) (1000 ft maximum externally powered or 500 ft maximum dry contact)

1. Confirm power is disconnected from the Controller.
2. Set jumpers to desired position.
3. Connect the switches to the Controller. Connect one lead from the switch to ground terminal (G) and the other to the appropriate input terminal. Momentary switches, which have both an ON and OFF contact, require two input terminals on the controller. (See page 19 for wiring diagram)
4. If applicable, connect additional switches to the LEXP card.

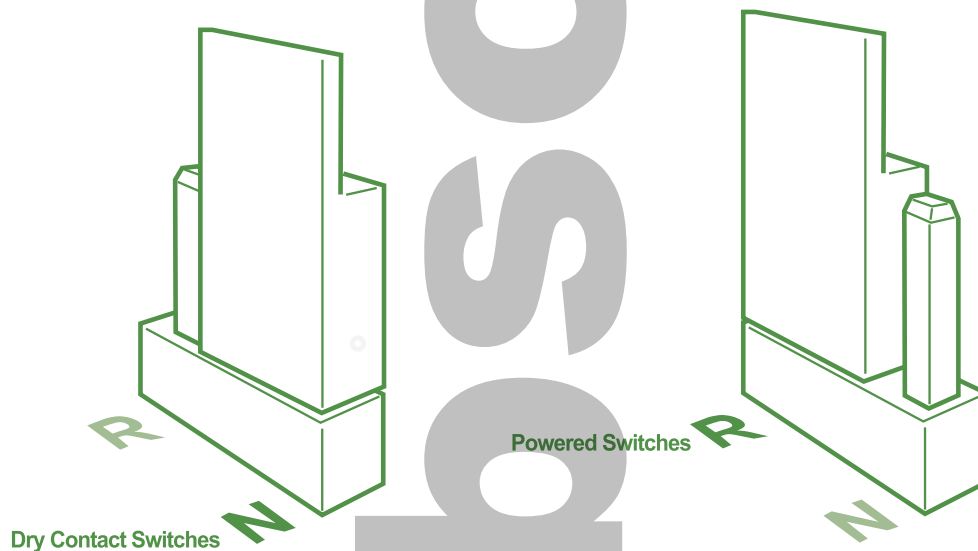

(Figure 12)



If one switch input is dry (0 VDC) the entire section of eight switch inputs must also be dry contacts and the associated jumper must be in the (N) position. If one switch input is powered (5 to 24 VDC) the entire section of eight switch inputs must also be powered and the associated jumper must be in the (R) position.

Connections : Switches and Polarity

Controller

- 1 Switch Input Jumpers : J5 (1-8)
- 2 Switch Input Jumpers : J23 (9-16)
- 3 Switch Input Jumpers : J4 (17-24)

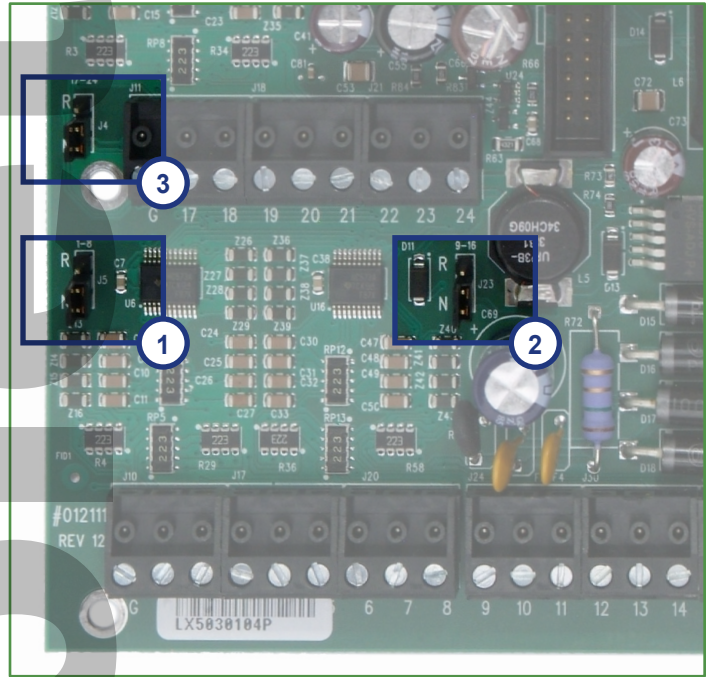

LEXP

- 1 Switch Input Jumpers : J4 (1-8), J5 (9-16)
- 2 Switch Input Jumpers : J13 (17-24), J9 (25-32)
- 3 Identification Jumpers : J18 (A-B), J19 (C-D)

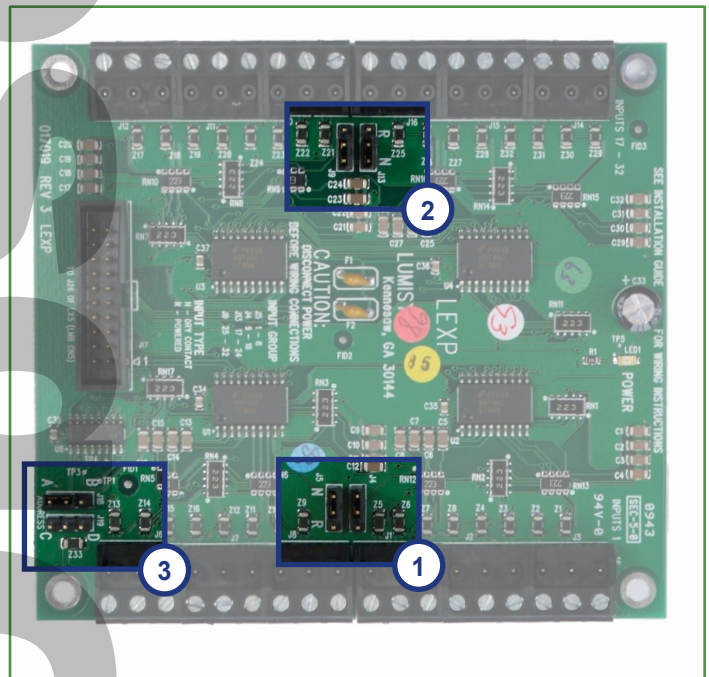

(Figure 13)

Connections : Switches and Polarity

Switch Input (Dry Contact : Low Voltage Switch)

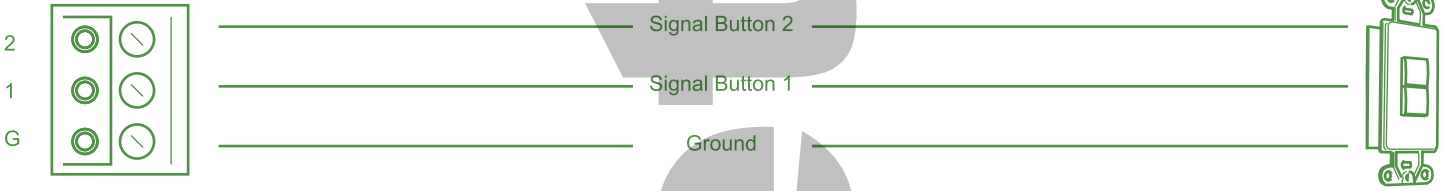

Switch Input (Externally Powered : Low Voltage Switch)

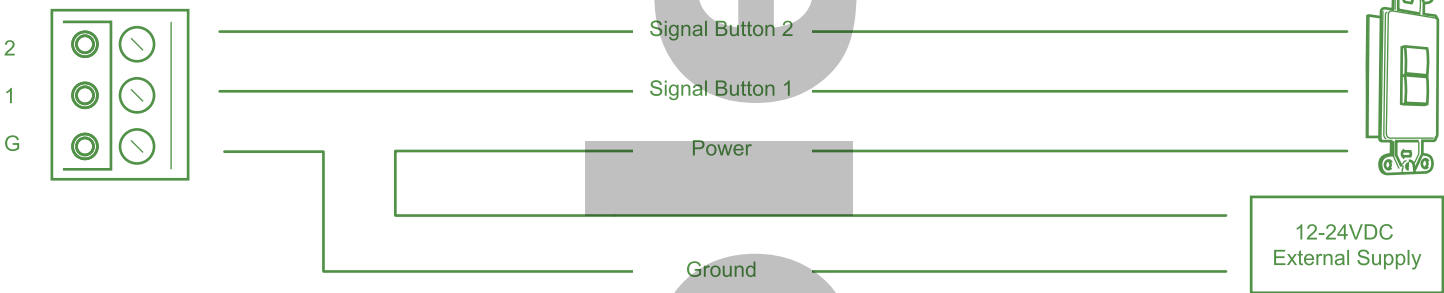

Switch Input (Dry Contact : 24V Occupancy Sensor)

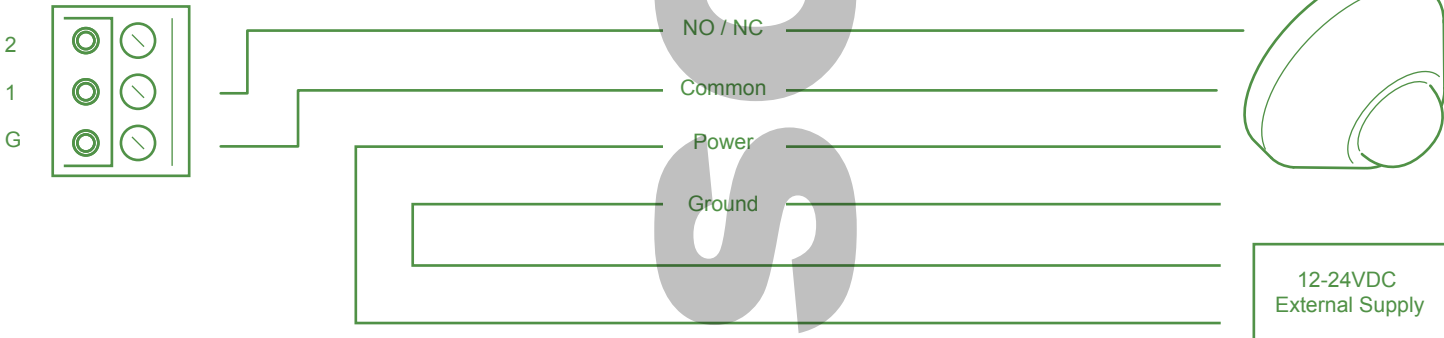

Switch Input (Externally Powered : 24V Occupancy Sensor)

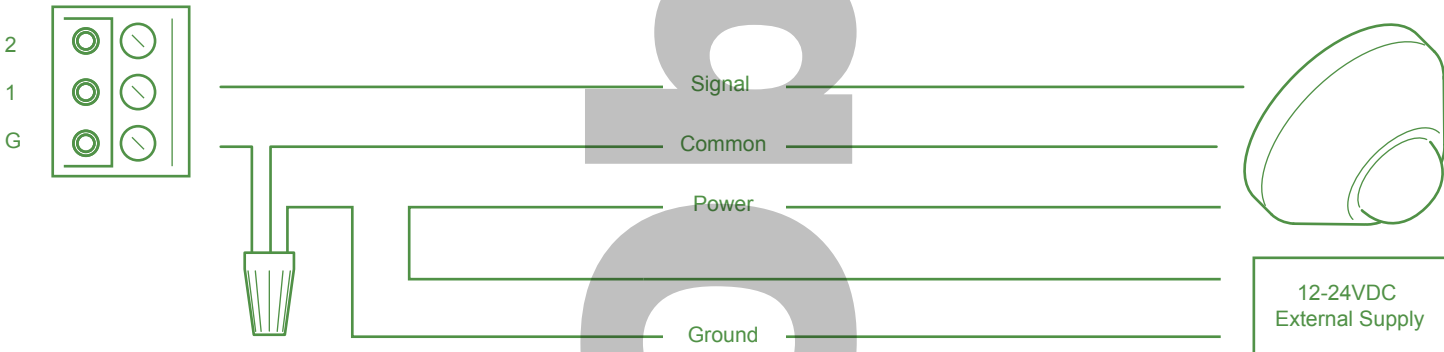

(Figure 14)

Connections : Analog Inputs

The Controller comes with six analog inputs for the LS5 Series Photocells. Each LS5 photocell ships with one 3 wire pigtail wiring harness. The photocell is powered by 5V from the Controller. The power circuit includes the Red (5V hot) and the Black (ground) wires. The yellow wire carries the 0-5V input signal from the photocell which is software scalable.* All analog inputs are connected to the Analog Input Socket. (Figure 15)

Wire Requirement : 18 AWG (Solid or Stranded, non twisted, un-shielded wire only) (250 ft maximum)

1. Confirm power is disconnected from the Controller.
2. Join red wires from all LS5 sensors into pigtails and connect terminal 8 (marked 5V) on the Analog Input Socket.
3. Connect each yellow signal wire from each LS5 sensor into individually marked A1-A6 on the Analog Input Socket.
4. Join black wires from all LS5 sensors into pigtails and connect terminal 1 (marked G) on the Analog Input Socket.

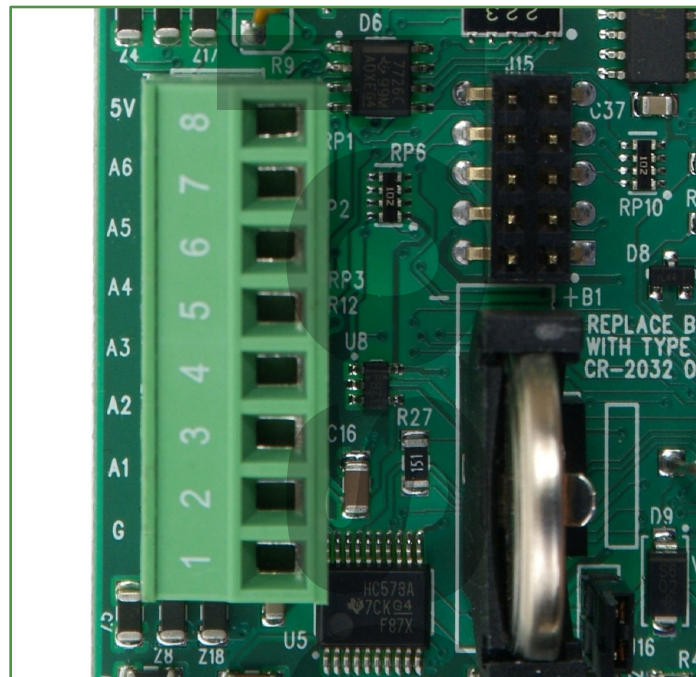

(Figure 15)

Analog Input (5V Light Level Sensor)

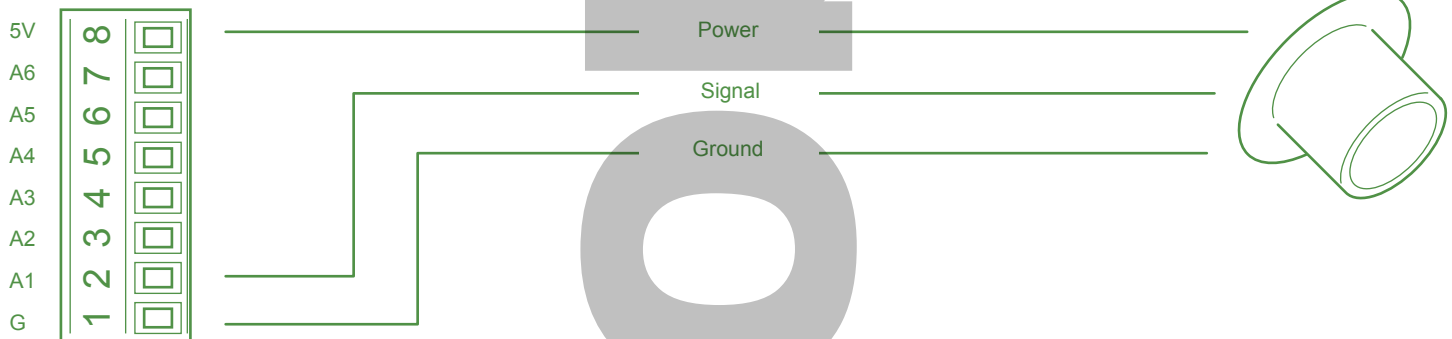

* Refer to LS5 Installation Guide for detailed wiring instructions.

Connections : Digi-Touch

The Controller can be used to loop power up to 10 Digi-Touch switches. Higher quantities of switches may be incorporated with a 24VDC auxiliary power supply.*

Connect the network of switches to the Controller Digi-Touch Terminal Block (marked DDN/CAN) and set the jumper to DDN (D position). Both Digi-Touch switches and Controller terminals are marked (24, L, H, and G) Correct orientation must be maintained when making connections. (Figure 16)

Wire Requirement : Belden 1502P or equivalent (250 ft maximum)

1. Confirm power is disconnected from the Controller.
2. For ease of wiring remove the Digi-Touch Terminal Block to reveal terminal labels.
3. Connect the power wire to the terminal marked 24.
4. Connect the Low Side signal wire to the terminal marked L.
5. Connect the High Side signal wire to the terminal marked H.
6. Connect the ground wire to the terminal marked G.
7. Reinstall the Digi-Touch Terminal Block.

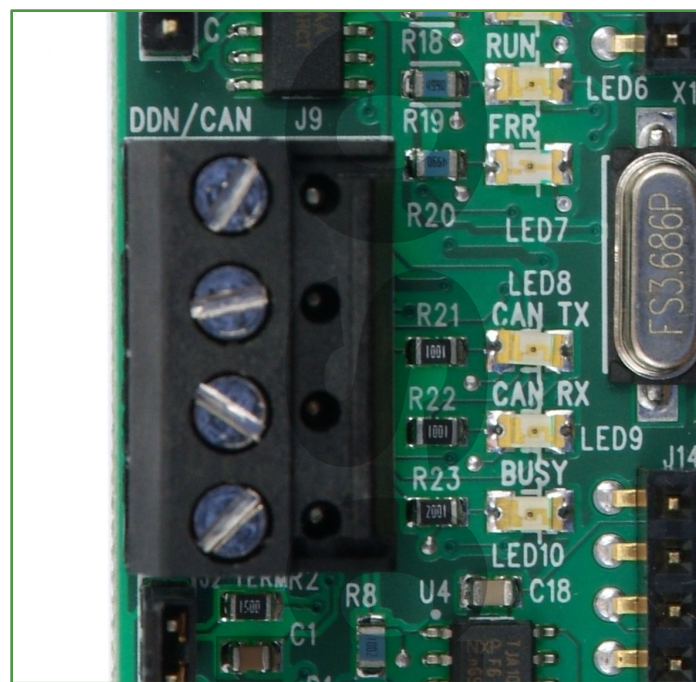

(Figure 16)

Digital Network (DDN Switches)

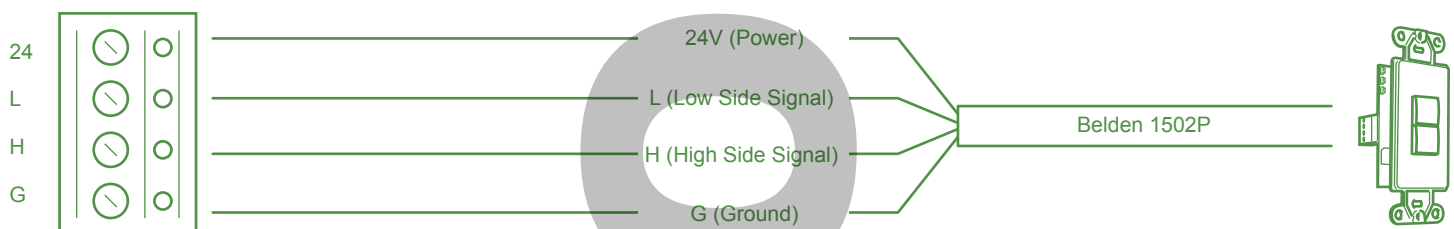

* Refer to Digi-Touch Data Sheet and Install Guide for detailed instructions.

RK Power Connection

The Retrofit Kit may now be connected to power and tested for operation.

All Retrofit Kits require a 24VAC full wave power supply. Power wires from the transformer should be 18 AWG stranded. A terminal block located near the bottom right corner of the Controller is provided for the power connection. *

1. Ensure line voltage power is disconnected from the panel.
2. Strip power wires from the transformer.
3. Remove the terminal block from the Controller and land the wires. (Figure 17)
4. Reconnect the line voltage power to the panel.
5. Confirm the transformer is supplying the proper voltage (24VAC).
6. Reconnect the terminal block to the Controller.
7. Verify that the Controller is operating normally (Power LED will illuminate and Run LED will blink continuously) (Figure 18). ¹
8. Confirm each RIB is powered (Power "P" LED (both RIB's) and "S" LED (RIB-A) will illuminate). (Figure 19)

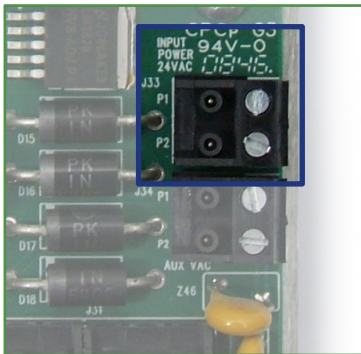

(Figure 17)

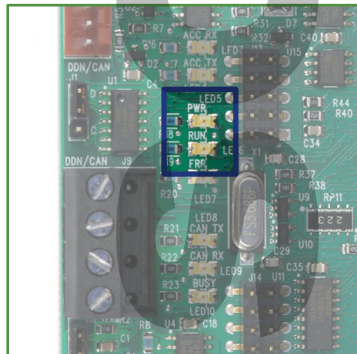

(Figure 18)

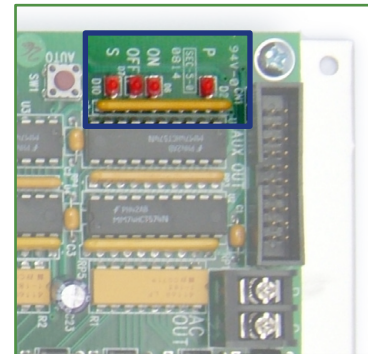

(Figure 19)



¹If the Controller is not operating normally, check all power wires to verify proper connection and voltage. If the condition continues contact Blue Ridge Technical Support.

* Refer to Lx5 Hardware User Guide for Controller component location.

Additional Configurations : RK4-L Overview

The RK4-L includes the following items (Figure 20) :

- 1 - Lx5 Controller
- 1 - Relay Interface Board (RIB-A) with (30) outputs.
- 1 - Relay Interface Board (RIB-B) with (30) outputs.
- 2 - 2-Wire RIB Power Pigtails (17" Total Length).
- 1 - 14-Pin Ribbon Cable (18" Total Length).
- 1 - 20-Pin Ribbon Cable (31" Total Length).

- 1 - LEXP Input Expander with (32) inputs
- 1 - 20-Pin Ribbon Cable (61" Total Length).

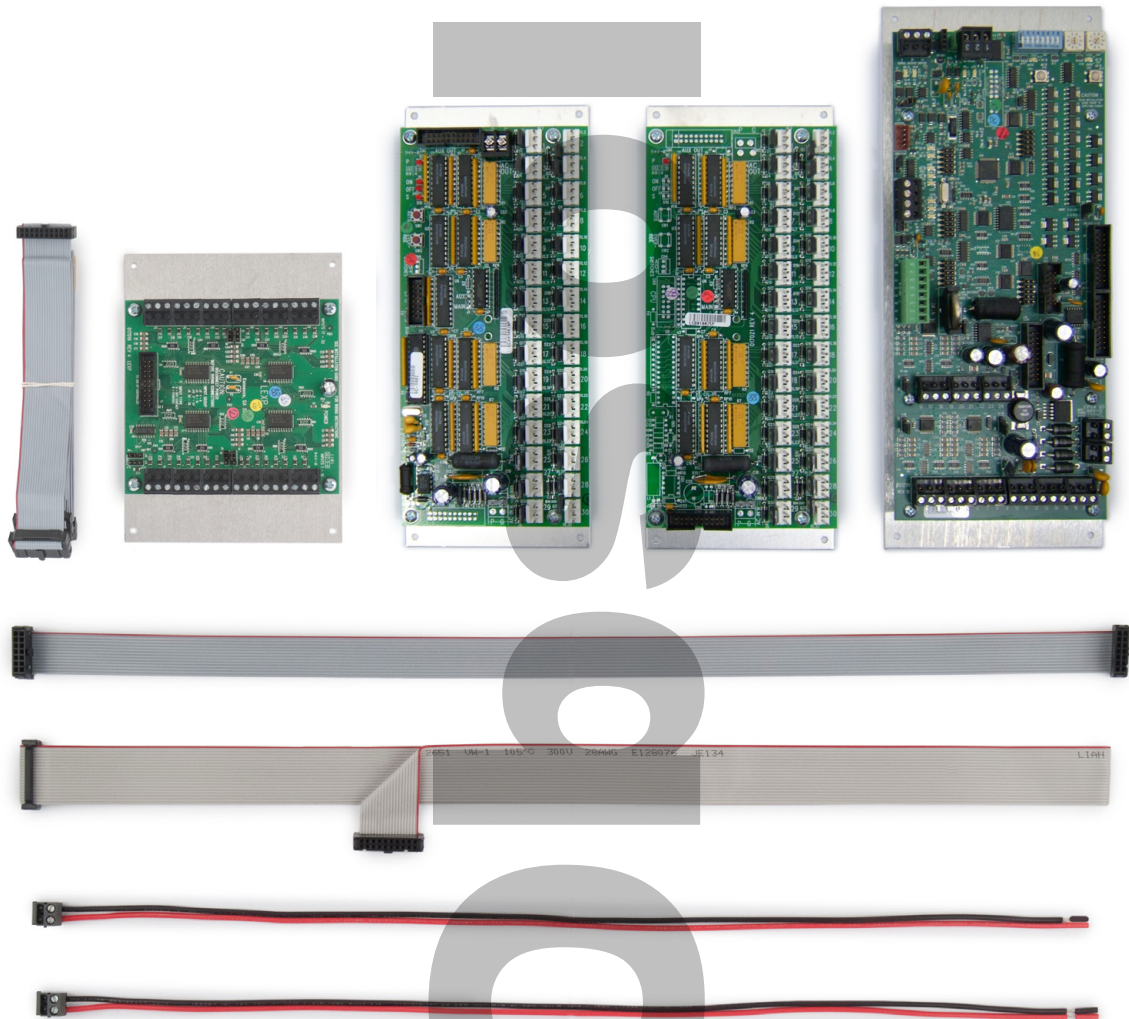

Figure 20)



RK Configuration Worksheet

RIB-A

RIB Output Number	Original Relay Number	Area Controlled	Original Input Number
1			
2			
3			
4			
5			
6			
7			
8			
9			
10			
11			
12			
13			
14			
15			
16			
17			
18			
19			
20			
21			
22			
23			
24			
25			
26			
27			
28			
29			
30			



RK Configuration Worksheet

RIB-B

RIB Output Number	Original Relay Number	Area Controlled	Original Input Number
1 (31)			
2 (32)			
3 (33)			
4 (34)			
5 (35)			
6 (36)			
7 (37)			
8 (38)			
9 (39)			
10 (40)			
11 (41)			
12 (42)			
13 (43)			
14 (44)			
15 (45)			
16 (46)			
17 (47)			
18 (48)			
19 (49)			
20 (50)			
21 (51)			
22 (52)			
23 (53)			
24 (54)			
25 (55)			
26 (56)			
27 (57)			
28 (58)			
29 (59)			
30 (60)			